

# CONNECT

THE MAGAZINE OF THE GLOBAL BBR NETWORK OF EXPERTS

Edition 8 | 2014

## NEW HORIZONS – PAST, PRESENT AND FUTURE

Revealing how the BBR Network has stayed one step ahead for 70 years

## INNOVATIVE TUNNEL CONSTRUCTION

Creating new approaches to deliver Zurich rail link tunnel

## UNCLOGGING THE BOTTLENECK

Rising to the challenges of widening a major expressway in Singapore

## EUROPE'S LARGEST LIFT BRIDGE

Realizing new infrastructure for expansion of Europe's biggest port at Rotterdam

## GOING UNDERGROUND

Specialist techniques for remedial work in major Auckland sewer



## **BBR** A Global Network of Experts

[www.bbrnetwork.com](http://www.bbrnetwork.com)

The BBR Network is recognized as the leading group of specialized engineering contractors in the field of post-tensioning, stay cable and related construction engineering. The innovation and technical excellence, brought together in 1944 by its three Swiss founders – Antonio Brandestini, Max Birkenmaier and Mirko Robin Ros – continues, 70 years later, in that same ethos and enterprising style.

From its Technical Headquarters and Business Development Centre in Switzerland, the BBR Network reaches out around the globe and has at its disposal some of the most talented engineers and technicians, as well as the very latest internationally approved technology.

### **THE GLOBAL BBR NETWORK**

Within the Global BBR Network, established traditions and strong local roots are combined with the latest thinking and leading edge technology. BBR grants each local BBR Network Member access to the latest technical knowledge and resources – and facilitates the exchange of information on a broad scale and within international partnering alliances. Such global alliances and co-operations create local competitive advantages in dealing with, for example, efficient tendering, availability of specialists and specialized equipment or transfer of technical know-how.

### **ACTIVITIES OF THE NETWORK**

All BBR Network Members are well-respected within their local business communities and have built strong connections in their respective regions. They are all structured differently to suit the local market and offer a variety of construction services, in addition to the traditional core business of post-tensioning.

### **BBR TECHNOLOGIES & BRANDS**

BBR technologies have been applied to a vast array of different structures – such as bridges, buildings, cryogenic LNG tanks, dams, marine structures, nuclear power stations, retaining walls, tanks, silos, towers, tunnels, wastewater treatment plants, water reservoirs and wind farms. The BBR brands and trademarks – CONA®, BBRV®, HiAm®, HiEx, DINA®, SWIF®, BBR E-Trace and CONNÆCT® – are recognized worldwide.

The BBR Network has a track record of excellence and innovative approaches – with thousands of structures built using BBR technologies. While BBR's history goes back over 70 years, the BBR Network is focused on constructing the future – with professionalism, innovation and the very latest technology.

BBR VT International Ltd is the Technical Headquarters and Business Development Centre of the BBR Network located in Switzerland. The shareholders of BBR VT International Ltd are: BBR Holding Ltd (Switzerland), a subsidiary of the Tectus Group (Switzerland); KB Spennteknikk AS (Norway), BBR Polska z o.o. (Poland) and KB Vorspann-Technik GmbH (Germany) – all three are members of KB Group (Norway); BBR Pretensados y Tecnicas Especiales PTE, S.L. (Spain), a member of the FCC Group (Spain).

# INNOVATION MEETS COMMITMENT

In 2014, BBR marks the 70th Anniversary of its founding which was firmly rooted in the Swiss values of technical excellence, quality service and commitment to innovation. Seven decades later, BBR Network Members continue to apply these principles to meet the challenges of new and often innovative projects, delivering the highest quality construction engineering solutions around the globe.



As well as CONNÆCT 2014, this year we are producing a special BBR 70th Anniversary magazine (see next pages) – contact your local BBR Network Member to secure a copy.

In the Portfolio section of this edition of CONNÆCT, you will see that teams of BBR PT Specialists the world over are engaging proactively with customer requirements to provide and maintain the infrastructure that we need to conduct our daily lives.

Innovation and excellence can clearly be seen in recent BBR Network projects – such as the stunning new footbridge in Auckland, New Zealand and the widening of the Keppel Viaduct, a major highway in Singapore. Equally, a post-tensioned approach to buildings – with the support of qualified professionals from within the BBR Network – is delighting customers for commercial, residential and public buildings, as well as car parks. One thing shines through loud and clear – the BBR Network has the specialist technology and know-how to satisfy some of the most demanding projects on the face of the earth... and, if a solution does not already exist, they will devise and design one! This is admirably demonstrated by Members' work on a city center railway tunnel in Zurich and on foundations for a new container port on the Adriatic.

You can also check out the latest news and views in Talking BBR which, this time, includes interviews with BBR management who share their thoughts on aspects of the business and an overview of BBR events around the world over the last 12 months.

Last but not least, in the Technology section, we share updates on BBR technology and R&D, as well as information about specialist techniques – such as MRR and tendon prefabrication – used by BBR Network Members to deliver customer requirements effectively.

In this 70th Anniversary year especially, we would like to take the opportunity to thank all the BBR project managers and engineers, BBR site managers and technicians – and, of course, the senior management within each BBR Network Member – around the world for the part they have played in carrying both our technological development and dedication to customer service forwards. Together, we have created a blueprint for sustainable success.



# BBR 70TH ANNIVERSARY

1944-2014

## TIME TRAVEL WITH BBR

The award-winning Sunniberg Bridge – near the Swiss alpine ski resort of Klosters – represents the culmination of years of technological development at BBR, combined with the skills and inspiration of leading Swiss designer Christian Menn. The story of the realisation of this bridge, along with many other articles about BBR's great past, present – and future – will shortly feature in a special 70th Anniversary magazine which will mark our milestone anniversary.

Prepare to be amazed at the innovation applied by BBR in the early days and wonder at the ambitious schemes undertaken.

It's a breath-taking journey through:

- world-record construction projects of every size, shape and type
- collaboration with some of the world's greatest engineers and architects
- evolution of the BBR business model into the world's first franchise of its kind

BBR has a stunning heritage stretching back over seven decades and today, by

always keeping one step ahead, still has the very latest technology – and an innovative business model which reflects the current and upcoming needs of the global market place.

This special edition examines the earliest days of BBR technology, its development over the past 70 years, our Swiss roots and values, plus an insight into some of the pioneering techniques and most exciting projects, as well as offering a glimpse into the future. Copies are available from your local BBR Network Member.

# ANNIVERSARY QUIZ

Test your knowledge of BBR and let us know if you can name the projects shown in the following photographs. To receive a special BBR 70th Anniversary prize, the winning entrant must identify all five projects correctly – stating the project name and its location. Entries should be sent to [info@bbrnetwork.com](mailto:info@bbrnetwork.com) and must be received by 31st July 2014.



1



2



3



4



5

# CONTENTS

07

## TALKING BBR

- 08 BUSINESS REVIEW
- 11 CONFERENCE NOTES
- 12 A YEAR TO REMEMBER
- 14 PERSPECTIVE

15

## PORTFOLIO

- 16 BRIDGES
- 33 BUILDINGS
- 44 STAY CABLES
- 47 TANKS & SILOS
- 50 SPECIAL APPLICATIONS
- 58 MRR

63

## TECHNOLOGY

- 64 RESEARCH & DEVELOPMENT
- 68 TECHNICAL UPDATE
- 70 TECHNIQUES
- 72 INSIGHT

77

## BBR DIRECTORY

## EDITORIAL, SOURCES AND REFERENCES

### EDITORIAL OFFICE

BBR VT International Ltd  
Technical Headquarters and Business Development Centre  
Switzerland  
[www.bbrnetwork.com](http://www.bbrnetwork.com)  
[info@bbrnetwork.com](mailto:info@bbrnetwork.com)

### EDITOR

Jane Sandy

### CONTRIBUTING EDITOR

Juan Maier

### DESIGNER

Jenny Chillingworth

### CONTRIBUTORS

George Ajaman, Kresimir Bogadi, Norbert Bogensperger, Antonio Caballero, Chee Cheong Chang, Ron van Dijk, Lee Jian Feng, Richard Gaskill, HM Goh, Christophe Gout, Peter Higgins, Warwick Ironmonger, Tomasz Jendernal, Sean Kelly, Tan Yeow Koon, Chuen Lin Lee, Bartosz Lukijaniuk, Behzad Manshadi, Valentina Mihajlovic, Claude Néant, Tim Pahapill, Fabian Persch, Jan Piekarski, Vince Ponzio, Thomas Richli, Mark Sinclair, Rey Singh, Stig Sjolbør, Oliver Smith, John Taraldsen, Tore Thorstensen, Guillaume Wastiaux, Paul Wymer, Janelle Yeo

### PUBLISHER

BBR VT International Ltd

### NUMBER OF COPIES

8,000

Every effort is made to ensure that the content of this edition is accurate but the publisher accepts no responsibility for effects arising there from.

p-ISSN 1664-6606

e-ISSN 1664-6614

© BBR VT International Ltd 2014

### SOURCES AND REFERENCES

#### Portfolio section

Crushing victory:

[www.cimentsdelarochelle.fr](http://www.cimentsdelarochelle.fr) (accessed January 2014)

Reviving a bold statement:

[www.theparabola-kensington.co.uk/the\\_parabola\\_book.pdf](http://www.theparabola-kensington.co.uk/the_parabola_book.pdf)

(accessed January 2014)

Symbol of progress:

[www.euroinfrastructure.eu](http://www.euroinfrastructure.eu) & [www.premier.gov.pl](http://www.premier.gov.pl) (accessed January 2014)

Containing strength for Adriatic:

[www.portauthority.hr](http://www.portauthority.hr) (accessed January 2014)

This paper is manufactured with 15% recycled fibre, FSC certified.

All pulps used are Elemental Chlorine Free (EFC) and the manufacturing mill is accredited with the ISO14001 standard for environmental management. Vegetable based inks have been used and 85% of all waste associated with this product has been recycled.



## TALKING BBR

### 08 BUSINESS REVIEW

Thomas Richli and Dr. Antonio Caballero share observations on the past and visions for the future

### 11 CONFERENCE NOTES

reflections on the 2013 Annual Global BBR Conference in Auckland, New Zealand, shared by Juan Maier, from BBR HQ

### 12 A YEAR TO REMEMBER

a small selection of BBR Network highlights from around the globe – events, awards and training

### 14 PERSPECTIVE

BBR VT International's newest Board member, Tore Thorstensen, offers his take on what makes the BBR Network so successful

## BUSINESS REVIEW

BBR VT's senior executives reflect on learning and direction

# NEW HORIZONS – PAST, PRESENT AND FUTURE

The 70th Anniversary of BBR's founding in 2014 presents an interesting opportunity to reflect on the past, the present and the future.

BBR VT International Ltd's CEO, Dr. Antonio Caballero and Thomas Richli, Chief Business Development Officer, share their observations and visions for the future.

## Why is history relevant to today – and to the future?

**TR:** People sometimes say that we need to understand where we have been, so that we can understand where we need to go. In the case of BBR, it's clear that when Max Birkenmaier, Antonio Brandestini and Mirko Robin Roš began the partnership they knew they had created something special – something useful – and they were taking the right steps to ensure their ideas would be developed further.

They were creating something which did not exist before, their goal was the development of new and reliable construction technology. They networked energetically on the architecture and construction engineering scene to raise awareness of their technology

and then, with the enthusiasm and support of contacts, commercialized it globally. As time passed, they saw opportunities to expand the range of technology – and, through the foundation of Proceq, even developed a range of equipment to help in their work.

**AC:** Our history gives us our identity – our founders' interest in and their passion for coming up with something new certainly continue today. Back then, the business was technology driven, today it is driven by customer needs. However, the quest for further knowledge and improvement on all fronts will never end – the journey begun in the 1940s will continue long into the future.







**What are the main differences in BBR's position today compared to 70 years ago?**

**TR:** Perhaps the biggest thing is that the BBR brand is now recognized the world over. Most engineers know the BBR brand and recognize it represents quality Swiss engineering technology. Thus, our Network Members experience a positive acceptance of BBR technology by their customers. The BBR reputation for quality and reliability has been won over 70 years – this is a great advantage for the BBR Network.

**AC:** As well as quality, the BBR brand also represents the latest technology, qualified professionals and experience gained in literally thousands of applications. Another major difference is the Global Network of Experts we have established over recent years and will continue to strengthen. Of course, harmonization of standards – embodied by EC and ETA – has also occurred. This was one reason why the BBR Network was established – to share costs and focus. BBR HQ provides a full package of latest technology including development, testing, approval and supply chain as well as related services such as marketing support, brands, publications, training seminars and so forth for its Members. This enables Members to concentrate on local sales, installation and engineering.

**TR:** These issues are important because they allow BBR Network Members to focus on their work, rather than becoming distracted by supply or regulatory issues. Ultimately, it allows them to provide the best possible service to their customers.

**How do today's challenges compare with those the BBR founders faced?**

**AC:** The first challenges were purely technological and probably the greatest challenge – to create new technology such as BBRV from scratch and build a reputation for it. Now the situation is different, BBR technology has been used for years in many countries. The challenge today is to find new ways of using the technology. For example, the use of external post-tensioning for strengthening structures is a comparatively recent innovation which relates our technology to current needs. Extending the lifetime of mature structures is becoming a major issue today, particularly in Europe. All over the world, BBR technology is being used for new applications that simply did not exist back then – like using post-tensioning in the construction of towers for wind energy projects. ►

**TR:** In the past, the economic situation was completely different. After the Second World War, there was huge demand – people needed road and rail networks – and a shortage of materials, engineers and reliable technology. Today, cost pressures are perhaps greater than, say, six decades ago – and the world has become a more complex global trading environment. A large percentage of money invested in infrastructure or buildings goes into strengthening or renovation. Different techniques, equipment and know-how are needed for these and the Network can provide the expertise to meet this demand. The BBR Network today is able to offer a wider range of complex construction engineering solutions beyond post-tensioning and stay cables (see also pages 72-75). Cost-efficiency is the order of the day and here, at BBR HQ, we too are always looking for ways to optimize costs for the BBR Network, to give our Members greater opportunity to be even more competitive.

**AC:** Yes, we are evaluating ways of further streamlining cost blocks, such as material sourcing, equipment, logistics and centralized teams or services and where there is an advantage, we will make changes. With the transformation of the corporate business model to a franchise system, centralization of certain functions makes sense as it saves time, effort and costs. Reducing duplication of effort has been at the heart of our approach in this context and, while there is yet more work to do, efficiencies have already been achieved.

**And what have been the most significant changes in the market?**

**AC:** The obvious change is that the market is now a highly competitive global one in which the benefits of post-tensioning and stay cable technologies are generally well-understood and established. Today, what the BBR Network can offer as a package is massive. For example, packages have included bridge construction techniques and services, linked with provision of bridge construction equipment, PT bars and so on. The Network continuously increases the scope to deliver tailored solutions and meet customer needs more effectively. Collaborative ventures between BBR Network Members are occurring more-and-more frequently and we see the basis for this at BBR Network gatherings.

**TR:** There has been a shift, not just in construction, but in every industry towards a more customer-focused business environment. A deeper understanding of the needs of customers has become vital for conducting successful business. Along with this, organizations should be able to supply a complete service – whether the job is small or large. This is where having strong back up and access to an international organization – such as the BBR Network – helps in forming the right package or offering and this also keeps us constantly innovating. In fact, one of the main strengths of the BBR Network is that its Members are locally based companies and professionals who have strong local knowledge, yet have the backing of an international 'Network of Experts'.

**What factors do you think will bring success in future decades?**

**AC:** The wealth of know-how that has accumulated over the past seven decades is significant. It will continue to grow and to feed our commercial and technological development in the future. Innovative know-how – and the way in which it is shared and used – will increasingly become a differentiating factor for successful organizations. That's why we place so much emphasis on creating new opportunities, networking with other organizations, developing channels and resources for the exchange of information – this is something we are constantly reviewing, refining and extending.

**TR:** As I mentioned earlier, listening and responding closely to customer requirements is essential to ensuring future business success. We are always striving to do this – and, again, if you look back at BBR's history, this is what we have always done. BBR may have started with a simple prestressed beam, but progressively grew the technology – in response to changing customer requirements – into a full range of technologies supporting both private and public sector clients all over the world. And, of course, BBR also developed an entire global Network to ensure quality implementation of construction technology-based solutions.

So, key factors are having an excellent understanding of the market needs, continuous innovation and excellent quality to bring added value for our customers – this is where we need to go. ●



1

1 Dr. Antonio Caballero – CEO, BBR VT International Ltd (top). Thomas Richli – Chief Business Development Officer, BBR VT International Ltd (bottom).

## ANNUAL BBR GLOBAL CONFERENCE, AUCKLAND, NEW ZEALAND

Technical updates, networking and knowledge exchange

# CONFERENCE NOTES

The 2013 Global BBR Conference in Auckland, New Zealand was always set to be a stunning event – taking place as it did in the local BBR Network Member's 50th Anniversary year. BBR VT International's Senior Business Development Manager, Juan Maier, presents a report of the occasion.

## 2013 BBR AWARD WINNERS

### BBR NETWORK PROJECT OF THE YEAR

Rio Corgo Viaduct, Portugal, executed by BBR PTE (Spain)

### BEST ARTICLE AWARD

- Joint winner: BBR PTE (Spain)  
Title: Waltzing over the Danube (Danube Bridge 2 in Bulgaria & Romania)
- Joint winner: ETIC (France)  
Title: Highway to the snow (Bellegarde Viaduct, A40 Geneva to Lyon section of the A4 motorway in France)
- Highly commended: BBR Polska (Poland)  
Title: Symbol of development & modernity (Przemysl Bridge, Southern Poland)

### BEST PHOTOGRAPHY AWARD

- Winner: SSL Structural Systems (Africa)
- Runner up: BBR Construction Systems (Malaysia)
- Highly commended: Spanstaal – Ballast Nedam Infra Specialiteiten B.V. (Netherlands)

Most importantly of all, the Annual Global BBR Conference is about getting all delegates together under one roof, to gather the opinions of people with much industry experience and wisdom. The ultimate goal – for all of us – is to improve our operations and way we go to market in the future.

### Tee-ing off

The Conference began, as is now customary, with the BBR Charity Golf Tournament which highlighted a wide range of skills and abilities – and provided an opportunity to get people talking. As delegates tee-ed off for the eighth and ninth holes of this stunning coastal golf course, the concentration of even the most focused player was challenged as they faced the dramatic view of waves crashing at the foot of the cliffs opposite. The event literally got the ball rolling for a lively and informative conference – while emphasizing the importance of continuous performance improvement to some of us!

### In session

Formal conference proceedings were opened by Thomas Richli who outlined the program and officially welcomed the new Swiss franchisee, Stahlton Ltd, to the BBR Network and introduced their Product Manager PT, Fabian Persch who gave an overview of the Swiss market place. Next was a presentation by Vanesa Salva from local BBR Network Member, BBR Contech, about the innovative Pres-Lam technology which combines post-tensioning with laminated veneer lumber (LVL) for a seismically resistant construction solution. As well as BBR news, technology updates and workshops, the conference featured further keynote presentations about the benefits of PT for developers (Marcel Poser, Tectus), Kuala Lumpur LRT Extension project (King-Bang Tie, BBR Malaysia) and Sudan's Roseires Dam project (Mark Sinclair, SSL Australia). Guest speaker, Stuart Oliver of Holmes Consulting delivered a most informative session on seismic retrofit with PT. As always, there were ample opportunities for networking between BBR Network Members and the Conference concluded with site visits – taking in PT, MRR and slab-on-ground projects in the city. For me, one of the highlights was the emergence, during our training sessions, of another PT Grand Master – Rob Robinson of BBR Contech made the grade and joins a select group of highly skilled and experienced engineers with outstanding knowledge of the application of BBR post-tensioning systems. It would be wonderful to be able to make a similar award this June, at our 2014 Global BBR Conference in Interlaken, Switzerland. ●



## NEWS HIGHLIGHTS

Awards, events and more

# A YEAR TO REMEMBER

There was much to celebrate and many activities in-and-around the BBR Network during 2013. Here, we present a brief selection of some of the year's highlights.

#### **Fifth annual BBR Adria PT Seminar**

In June, the fifth annual BBR Adria Post-tensioning Seminar was held in Zagreb, Croatia – adjacent to two award-winning buildings constructed with BBR technology. The audience included engineers, architects and designers from around the region. Among the guest lecturers was BBR VT International's Antonio Caballero who spoke about the benefits of the BBR VT CONA CMX range in terms of sustainability, as well as some key points for design.

#### **Workshop highlights operational success**

A highly successful project managers' course was held during August in Brisbane, Australia. The 20 BBR engineers from Singapore, Malaysia, New Zealand and Australia studied the technical aspects of the BBR VT CONA CMX post-tensioning

range in practical and classroom scenarios, as well as sharing best practices in operational management, trouble-shooting on site, procurement practices and improvement of productivity during break-out knowledge sharing workshops.

#### **Golden Anniversary**

BBR Contech, the BBR Network Member in New Zealand, celebrated five decades of service to the construction industry – a half century in which it has earned an outstanding reputation for post-tensioning, ground anchoring, seismic strengthening, construction engineering and structural maintenance, repair and retrofitting. The company held 50th Anniversary functions – attended by staff, directors, key clients and partners – in Auckland, Wellington and Christchurch.





1



2



3



5



4

### Singapore celebrations

BBR Holdings (S) Ltd, parent company of BBR Network Member, BBR Construction Systems, marked two decades of operations in September with a celebration dinner, attended by some 800 guests, at the Marina Bay Sands Grand Ballroom, Singapore. The organization has grown beyond its original specialist engineering roots to offer civil and building works, as well as being a boutique developer in this region.

### Excellence award

The 2013 ASBI Bridge Award of Excellence has been awarded to the Danube Bridge 2 in Vidin-Calafat (Bulgaria / Romania). This bridge was completed by BBR PTE, Spain, who installed 2,100t of BBR VT CONA CMI post-tensioning, 65,000m of plastic duct and 208 BBR HiAm stay cables. It also featured the first use of the innovative BBR HiEx CONA Bundle Saddle for the extradosed bridge configuration.

### European Project Manager's Workshop in Zagreb

The most recent European Project Managers' Workshop saw engineers from across Europe gathering in Zagreb, Croatia for three days. This year's session focused on PT slabs and covered a broad range of topics – including slab design considerations, marketing and offering for PT slab projects, as well as procurement and installation. The whole team was also updated on the latest news from BBR HQ, given an overview of the newest range of CONA CMX accessories, while also sharing best practices in break-out working groups. At the end of the workshop, delegates visited a multi-storey construction project site to see the BBR VT CONA CMM Single PT anchor in action. ●

- 1 The Danube Bridge II in Vidin-Calafat, Bulgaria / Romania was declared winner of the 2013 ASBI Bridge of Excellence Award. Photograph courtesy of FCC Construcción.
- 2 Singapore-based BBR Holdings' 20th Anniversary was marked with a celebration dinner for 800 guests. Pictured here is CEO Andrew Tan being presented with a commemorative Swiss cow bell.
- 3 Directors of BBR Contech, the New Zealand-based BBR Network Member, joined with staff, clients and business partners at functions in Auckland, Wellington and Christchurch to celebrate 50 years of serving construction in New Zealand. Left to right: Andrew Dallas, Des Mataga, David Dorrington, Paul Wymer and Dr Ian Parton.
- 4 BBR Network engineers working together in a break-out session during the European Project Managers' Workshop in Zagreb, Croatia.
- 5 The BBR project managers' training course in Brisbane, Australia featured technical and workshop sessions.

## PERSPECTIVE

Strength and success through networking

# GREATER THAN THE SUM OF ITS PARTS



One of BBR VT International's newest Board Members is Tore Thorstensen, CEO of KB Gruppen Kongsvinger AS, Norway's largest family-owned building and construction company. He is also a member of the Board of Plantasjen – the largest retail garden center operation in Norway – where previously he served as the working chairman of the Board and before that, as CEO. Earlier roles include 18 years with Dyno Industrier, a speciality chemicals producer, latterly as executive vice president. We asked Tore to share his observations and thoughts on the reasons for the success of the BBR Network with CONNÆCT readers.

Over recent years, I have seen the technological developments taking place and witnessed the securing of European Approval for the range of CONA CMX technology. This has been a great success for our business and – along with our other well-established brands which are internationally recognized – has placed the BBR Network in a market leading position.

#### Global network

One of the greatest strengths of the BBR Network is, however, the network itself. Each Member has valuable local knowledge, as well as specialist skills – gained on projects particular to their region. Often, Members are part of a larger organization which, in turn, offers further specialist expertise and services.

When you put all of the available expertise, skills and specialist equipment together, you have an organization that is truly greater than the sum of its parts. There is no construction challenge on the planet that we could not rise to meet – together.

#### Maximum opportunities

The opportunities presented, through the BBR Network, for Members to literally 'network' are also a huge advantage. There can be no doubt that the information and best practice shared during such occasions contributes to the excellence of the service we provide to our customers – a world of knowledge, applied to local markets. It's a win-win situation.

When these dialogues – whether they actually begin face-to-face or through the BBR Forum or by other means – turn to broader capability issues, international collaborations can often form. This is

something that, personally, I find very exciting – partly because of the increased business generated by this approach for those Members involved and partly because of the inevitable skills transfer that happens in the course of executing the work, meaning that new technology, techniques or applications can then be applied to local markets, thus opening up new business opportunities in a Member's home territory.

#### Commitment to success

While all BBR Network Members depend on services from BBR HQ and sharing of communal knowledge, the independence of franchisees' individual businesses ensures the highest level of commitment to success. It is this commitment, I believe, that drives many of the good things which are happening within the BBR Network. Now is also the time for us to expand and strengthen the BBR Network by increasing our geographic coverage. We are ready to bring the BBR technology to territories in which we are not currently active and where, through changed market conditions, there are growing infrastructure needs. In this, BBR's 70th Anniversary year, we should take additional inspiration from the enterprise, innovation and dedication that the three founders applied to introduce completely new technology to the world market. We should continue to embrace that spirit in bringing established – and now the latest European Approved – BBR technology to new markets and applications, as well as to making our individual businesses even more successful through the very close ties afforded by being a Member of the BBR Network. ●



## PORTFOLIO

### BRIDGES

#### 16 INTEGRATING STRUCTURE & ENVIRONMENT

the new award-winning Point Resolution bridge in Auckland, New Zealand not only gives access, but also reflects local heritage

### BUILDINGS

#### 33 EARLY INVOLVEMENT FOR BEST SOLUTION

post-tensioned solutions for buildings, provided with BBR technology and know-how, have delivered real benefits for customers in Poland

### STAY CABLES

#### 44 SYMBOL OF PROGRESS

The new Przemysl Bridge, officially opened by the Polish Prime Minister, featured incremental launching and BBR HiAm CONA stay cables

### TANKS & SILOS

#### 47 BUILDING FOR BIOGAS

four massive digester tanks for biogas production in Hungary have been realized with BBR VT CONA CMM post-tensioning

### SPECIAL APPLICATIONS

#### 50 SLIDING WITH SAFETY & SPEED

Lateral bridge sliding was chosen to minimize impact on rail traffic during a regional railway link project in Western Australia

### MRR

#### 58 GOING UNDERGROUND

maintenance work on Auckland's 19km long Eastern Interceptor Sewer required the team to work inside the large wastewater pipe

POINT RESOLUTION TAURARUA FOOTBRIDGE, AUCKLAND, NEW ZEALAND

Award-winning post-tensioned concrete and steel pedestrian bridge

# INTEGRATING STRUCTURE AND ENVIRONMENT





An unassuming yet elegant pedestrian bridge giving access to Auckland's Parnell Baths, across railway tracks and the busy Tamaki Drive – which links the Point Resolution headland to the City's eastern suburbs, across Hobson Bay – has won the New Zealand Concrete Society's coveted 2013 Monte Craven Architectural Building Award. BBR Contech, the BBR Network Member based in New Zealand, is pleased to have contributed to the realization of this award-winning project.

The new Point Resolution Bridge replaces one originally built in two sections to connect Tamaki Drive with the Parnell Baths – a swimming complex built around half-a-century ago and featuring the largest salt water pool in New Zealand. When engineering experts assessed the bridge as having reached the end of its design life and thus in urgent need of refurbishment or replacement because of corroded steelwork, Auckland Council started looking for a long-term solution.

The end result is this glorious new structure, designed by award-winning architecture practice, Warren and Mahoney.

#### Architectural design

The bridge is made up of three connected precast post-tensioned concrete beams – forming a hull-like shape which makes a visual reference and connection to the harbor and yachts beyond. This structure is threaded through an external framework of painted steel featuring three sculpted arches – echoing the shape of the original bridge – connected by simple glass balustrades. The bridge deck provides a canvas for specially commissioned artwork that incorporates a delicate water ripple – or 'pungarungaru' – design which has been cast into the formed face of the precast beams. The ripple design continues on the clear glass panels of the balustrades. ➤

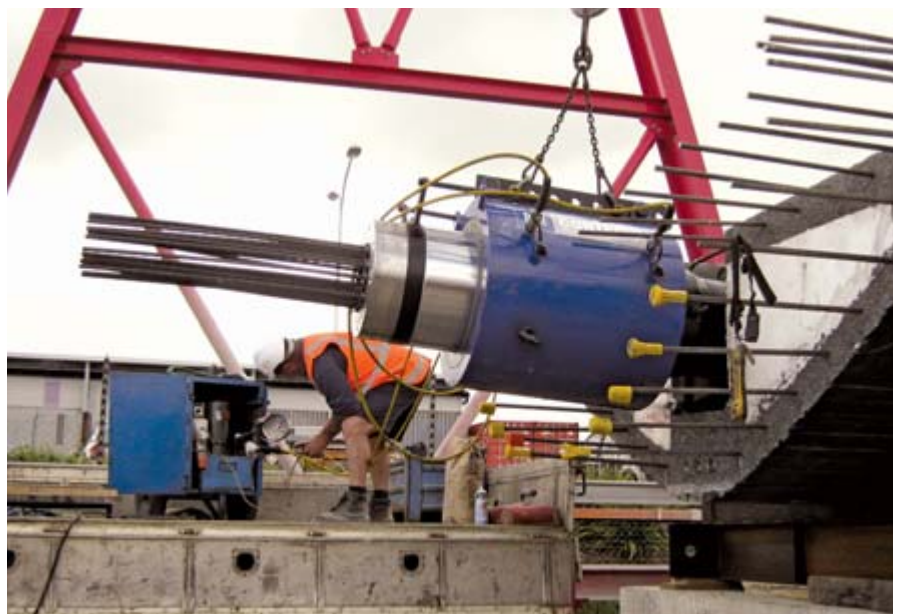



3

**Complex construction**

The bridge’s elegant visual simplicity belies the complexity of the construction task behind this project. Wilson Precast managed the process of integrating the detailed artwork into the precasting moulds, coordinating all aspects of the fabrication and then finally getting the 90t beams transported to site ready for lifting – no small feat.

“It was enormously challenging,” commented Duncan Peters, a Director of Peters & Cheung, the bridge’s design engineers. “Here were these enormous, incredibly heavy concrete beams being held up by virtual toothpicks – how could we ensure that the structure could be built, let alone stay stable and survive a disaster such as an earthquake?”

Duncan went on to say that great teamwork – which included working with Wilson Precast and BBR Contech to ensure integrity in the concrete beams through a comprehensive post-tensioning process – was key to the project’s success, especially given a construction timeframe of just 12 months.

The work started off-site, where the three precast beams were post-tensioned using tendons of between 22 and 25 strands, each 15.2mm in diameter. The beams were stressed using our brand-new 700t jack – with the largest beam stressed to 460t. It was critical to get this process right,” added Duncan. “Fortunately we’ve worked with BBR Contech before, so we knew they would deliver. It’s a credit to the whole team that this very complicated project went so well.”



4

**Elegant, clever & unobtrusive**

In making their award for the Monte Craven Architectural Building 2013, the Judging Panel at the New Zealand Concrete Society said:

“It is an elegant, clever and unobtrusive solution. The architecture and integration of structure and environment works perfectly – and showcases what can be achieved when value is placed on building structures that are highly functional and in sync with the environment. The twin-cell post-tensioned concrete bridge deck achieves the large spans, provides for low maintenance and offers a palette for incorporating the pungarungaru (ripples on the water) design reflected throughout other parts of the structure. This footbridge is a striking and memorable landmark structure that enhances the waterfront perspective – it is a poster child for concrete and the public will spend as much time admiring the bridge as they will the beauty of the Auckland landscape that surrounds it.”

Proposed by Monte Craven, The Monte Craven Architectural Building Award was first introduced in 1998 to encourage engineers and architects to work more closely together on construction projects involving concrete. The Point Resolution Bridge is a textbook example of how the entire professional team worked closely together to deliver an outstanding result for the client and the community for years to come.

BBR Contech is delighted to have been involved in this exceptional project and looks forward to playing its part in further award-winning schemes along with other members of the professional team for the Point Resolution Bridge. ●

“Fortunately, we’ve worked with BBR Contech before, so we knew they would deliver.”

Duncan Peters, Peters & Cheung

- 1 The deck of the award-winning Point Resolution Bridge is made up of three connected precast post-tensioned concrete beams – its hull-shape reflects the maritime setting.
- 2 The BBR VT CONA CMI tendons in the precast beams were stressed using a 700t jack, with the largest beam stressed to 460t.
- 3 Great teamwork between Wilson Precast and BBR Contech ensured integrity in the concrete beams through a comprehensive post-tensioning process.
- 4 The Judging Panel at the New Zealand Concrete Society commented that the project showed what could be achieved when value was placed on building structures that are highly functional and in sync with the environment.

**TEAM & TECHNOLOGY**

- Client** – Auckland Council
- Architect** – Warren and Mahoney
- Main contractor** – Hawkins Infrastructure
- Engineer** – Peters & Cheung
- Precaster** – Wilson Precast
- Technology** – BBR VT CONA CMI internal
- BBR Network Member** – BBR Contech (New Zealand)

## ROAD BRIDGES, JEDDAH, KINGDOM OF SAUDI ARABIA

Post-tensioning for two city center flyovers

# EASING TRAFFIC FLOW

Two new flyovers have been constructed as part of a long term plan to ease traffic flow around the city of Jeddah and meet the needs of the rapidly growing local population. BBR Network Member, Huta Hegerfeld Saudia Ltd, has provided post-tensioning services for both projects.

The projects are located at two intersections along Prince Majid Road – at Thahlia Street and Sari Street.

At the Thahlia Street intersection, a 220m long five span bridge – featuring a main span of 60m – has been completed. The deck contains three types of precast beams plus a cast in-situ section. Post-tensioning for the precast sections was achieved using BBR VT CONA CMI 0706 and 1206 systems. The cast in-situ section was post-tensioned with the CONA CMI 1206 system.

Meanwhile, at the Sari Street intersection, the flyover is a 315m long eight span bridge with a 41m main span, constructed entirely of prestressed precast beams. The beams were assembled in post-tensioned sets of one or two spans each and on four alignments. Longitudinal tendons were BBR VT CONA CMI 0706 and 1206, while the transversal post-tensioning for the crossheads was provided using CONA CMI 1206 and 1906 systems.

The two projects required a total of 320 tendons and 360t of prestressing strand. The completion of these two projects is a step on the way to achieving the city's ultimate plan of linking Prince Majid Road to Jeddah's Southern Corniche. ●



1



2

## TEAM & TECHNOLOGY

**Owner** – Municipality of Jeddah

**Main contractor** – Huta Hegerfeld Saudia Ltd

**Designer** – JL Cancio Martins / Trois Engineering Ltd

**Technology** – BBR VT CONA CMI internal  
**BBR Network Member** – Huta-Hegerfeld Saudia Ltd

1 Intersection of Prince Majid Road with Thahlia Street.

2 Intersection of Prince Majid Road with Sari Street.



ACCESS BRIDGE, CAHAYA SPK COMMUNITY, SHAH ALAM, SELANGOR, MALAYSIA

Curved viaduct launching

# ELEGANTLY CURVED BRIDGE

An elevated viaduct, over-flying an existing highway, was needed to provide a dedicated access to the community of Cahaya SPK, Shah Alam, Selangor. BBR Construction Systems successfully bid for this design and build project. HM Goh of BBR Construction Systems Malaysia explains the challenges surrounding this design and construct project for the 115m long box spine curved main viaduct.

The original viaduct design had an intermediate pier at the median to handle the long span and tight 60m radius horizontal curve. Construction of the intermediate pier within the narrow median strip would have been disruptive to traffic and dangerous to both road users and the construction contractor. As well as our keen pricing, the client liked our alternative proposal as it removed the need for an intermediate pier – and would also result in an exceptionally elegant bridge.

## Bridge configuration

The main bridge of the viaduct has a span configuration of 31m + 53m + 31m. The two approach ramps are comprised of cast in-situ reinforced concrete structures and reinforced earth walling. Structurally, the deck is made up of two precast box girders – which provide good torsional capacity to resist the effects from the bridge's curved geometry. Topography and terrain of the site dictated that the bridge geometry required a curve of 60m radius and a pier height of 8m.

## Construction planning

As the main bridge was being constructed directly above existing live traffic, it was impossible to adopt the cast in-situ method for the whole bridge – the setting up of temporary formwork would have caused long term closure to traffic of the highway beneath and, thus, serious inconvenience. Therefore, the precast method was adopted for the main span of the bridge.

To reduce the concrete self-weight during launching, the casting of the main span was divided into two box girders – outer beam and the inner beam. Each beam weighs less than 200t.

There were three construction stages:

- **Stage 1** – Falsework and formwork were erected to cast the approach spans. At the same time, precasting of the main span beams was carried out.
- **Stage 2** – After completion of stressing and grouting of the approach spans, the mid-span precast beams were launched on top of the piers. Each precast beam was hung in position by steel tie beams. Vertical 36mm diameter prestress bars were stressed to hold the steel tie beams.
- **Stage 3** – After launching the precast beams, the deck slabs between the two beams were stitched. The gaps between the ends of the precast beams and the approach beams were also stitched. Then the continuous BBR CONA internal 1906 tendons over the three spans were stressed to complete the continuous bridge superstructure.

<sup>1</sup> Challenges for the BBR team working on this elegant bridge included safety, terrain, buildability, aesthetics, space limitations and time constraints.

### Temporary works design & consideration

Temporary steel tie beams were necessary for the whole launching process, as it served as the main support member until the three span bridge was completed. The design of the tie beams was challenging due to the curved geometry. The center of gravity of the precast beam was away from the centerline of the alignment, thus the beam would tend to rotate if lifted at the ends. Therefore, two adjustable lifting brackets with multiple adjustments were fabricated to ensure that during the lifting operation, by two mobile cranes, the original center of gravity of the curved beam would be maintained. In securing each beam to the approach beam, high torsional moments and shear forces needed to be overcome. This was achieved by using a pair of Grade 50B steel tie beams stressed with vertical 36mm bars.

### Erection work

The launching of the two main beams was targeted to be completed in 48 hours, as the local authority only permitted the main road to be closed between 12am and 7am. Hence, the aim was to completely launch only one beam per night.

First, the beam was lifted by two 300t capacity cranes and placed on a multi-axle loader. The multi-axle loader transferred the beam to the launching point. The beam was lifted by 400t and 500t capacity cranes. When the beam was in position, stressing of the bars was carried out to secure the beam. The same process was repeated for the second beam during the following night.

### Completion

The whole bridge was opened to traffic on 8 September 2013 and now has become one of the important landmarks of the area. Road safety, challenging terrain, construction practicability, aesthetic value, working space limitation and time constraints have made this project both truly memorable – and extremely satisfying. ●

## TEAM & TECHNOLOGY

**Owner** – S.J Properties Sdn Bhd

**Main contractor** – BBR Construction Systems (M) Sdn Bhd

**Designer** – Perunding LFL

**Bridge contractor** – BBR Construction Systems (M) Sdn Bhd

**Technology** – BBR CONA internal, PT bars, Span-by-span precast

**BBR Network Member** – BBR Construction Systems (M) Sdn Bhd (Malaysia)



HUNTER EXPRESSWAY, NEW SOUTH WALES, AUSTRALIA

First use of BBR VT CONA CMI for RMS project

# MILESTONE FOR BBR TECHNOLOGY

Approval for use of the BBR VT CONA CMI system within Roads & Maritime Services (RMS) projects was granted in May 2012 and, just six months later, explains Project Manager Vince Ponzio, of BBR Network Member Structural Systems, it was being installed on a major freeway project in New South Wales.

The Hunter Expressway is a \$1.7 billion 40km, four lane freeway link between the F3 Freeway near Seahampton and the New England Highway west of Branxton. The western section of the project involves completion of 27km of the new freeway link, including four grade separated interchanges and a total of 25 bridges along its length.

Two interchanges – one located at Kurri Kurri (pictured above) and the other at Branxton – involved the construction of single span, cast in-situ post-tensioned box girder bridges over the new Hunter Expressway.

Structural Systems was awarded the contract for the supply and installation of post-tensioning services for these bridges. Each of the four bridges was approximately 40m in length featuring a combination of 1906 and 3106 CONA CMI multistrand tendons.

In total, 84 post-tensioning tendons were installed – requiring approximately 100t of 15.2mm strand and 3.5km of ducting. The new BBR VT CONA CMI system met all client expectations resulting in a highly successful project and positive client feedback. ●

## TEAM & TECHNOLOGY

**Owner** – NSW Roads & Maritime Services (RMS)

**Main contractor** – Abigroup Contractors Pty Ltd

**Designer** – SMEC / SKM

**Technology** – BBR VT CONA CMI internal

**BBR Network Member** – Structural Systems Limited (Australia)

## KEPPEL VIADUCT, SINGAPORE

Carriageway widening

# UNCLOGGING THE BOTTLENECK

The Keppel Viaduct – an awkward bottleneck on Singapore’s Ayer Rajah Expressway – is being upgraded from a dual three lane carriageway to a dual four lane carriageway. Singapore-based BBR Construction Systems’ Project Manager, Tan Yeow Koon describes the project’s history and explains how existing site conditions make both the design and construction a major challenge.



“...the live traffic environment and limitations imposed by existing structures made both the design and construction a major challenge.”

The Keppel Viaduct was constructed as part of the Ayer Rajah Expressway (AYE) from 1983 to 1988. At that time, it was the longest vehicular viaduct in Singapore – measuring 2.2km in length – and a crucial traffic corridor for east-west commuters as it connects the East Coast Park Expressway (ECP) and AYE. Both the ECP and AYE had been upgraded over the years into major dual four or five lane expressways, whereas the Keppel Viaduct was still only carrying a dual three lane carriageway. So, when the Land Transport Authority (LTA) finalized the plan to re-route the ECP-AYE connection with a new expressway – the Marina Coastal Expressway (MCE) – a study was carried out to look into the bottleneck caused by the Keppel Viaduct. While the LTA's objective to upgrade the dual three lane carriageway into a dual four lane carriageway looked simple on paper, the live traffic environment and limitations imposed by existing structures made both the design and construction a major challenge.

#### Design concept

Singapore Piling & Civil Engineering (SPACE), one of our sister companies within BBR Holdings Limited, was awarded the design and build contract by the LTA in February 2011. SPACE drafted in an equally well-established consultant on vehicular bridge design – YWL Engineering – and the first task on hand was to finalize the design concept for the major upgrading works. The existing crossbeams are to be extended to accommodate an additional three or four longitudinal beams, alongside the eight currently existing beams. To achieve this, the designer proposed an additional crossbeam, extension to the existing crossbeam, new columns sandwiching the existing one, plus the pile-cap resting above the existing pile-cap with new foundation pipes. With this design concept, the proposed structure will be able to accommodate additional longitudinal beams and the structural capacity of the viaduct will be enhanced.

#### Post-tensioned extension

To accommodate the widening of deck slabs at both ends of the viaduct, the design proposes an extension of the existing crossbeam, such that additional prestressed precast beams can then be launched upon the new extended structure. For this, a combination of utilizing two existing spare PT ducts and installation of new PT bars was proposed. To allow the existing crossbeams to carry the extra loads, new secondary crossbeams are to be constructed immediately beneath four of the existing eight beams. The new crossbeams are 25m in length, with a cantilevered arm of 9m. For this element of the work, a total of 10 post-tensioning tendons have been proposed, each having 38 strands of 12.9mm diameter and each tendon will ultimately have to be stressed to 5,320kN. ▶

- 1 Singapore's Keppel Viaduct, once celebrated for being the longest in the country, had become a bottleneck on the busy east-west commuter route.
- 2 Site conditions and constraints dictated the use of a T-shaped cantilevered steel truss tower, designed in modular segments, for construction of the crossbeams.
- 3 The completed crossbeams of the Keppel Viaduct, extended to accommodate an additional three or four longitudinal beams, alongside the eight currently existing beams.



**Substructures**

To support the entire proposed superstructure, a system of foundational substructures must be designed and constructed. Firstly, bored micropiles of 350mm diameter were proposed as the foundation system due to existing headroom limitations – the existing headroom clearance of 10m does not allow the deployment of standard bored-piling rigs and service cranes. Furthermore, micropiling rigs are much smaller and are more applicable for installation of piles right beside busy vehicular carriageways and junctions. The new pile-caps, designed as transverse beams across the existing pile-caps to fit within the existing center median, are then constructed and cast in-situ on site.

**Columns**

Similarly, to facilitate construction of the proposed columns in the middle of live vehicular carriageways on both sides, the steel reinforcement bars for the columns have to be prefabricated into cages, lifted and secured into place, followed by the installation of modular steel system formwork. All these activities are being carried out with the objective of causing minimal impact to the at-grade road vehicular traffic.

**Crossbeams**

To construct the new crossbeams, the conventional method of erecting falsework supports, followed by installation of reinforcement steel bars and formwork cannot be adopted. This is due to live vehicular traffic flanking both sides of the working space, as well as the headroom constraint below the viaduct restricting the use of cranes. Hence, a set of system falsework / formwork was proposed for this work. This falsework / formwork, fabricated with structural steel members, comes in the form of a T-shaped cantilevered steel truss tower. The system is designed in modular segments to facilitate the lifting operation at a more manageable level for each module. The modules are lifted, joined and fixed in place using nut-and-bolt connections. Lifting points at the viaduct soffit consist of steel pins and brackets that are fitted onto the existing beams of the viaduct.

**Construction challenges**

The nature and location of the scheme have brought some very specific challenges to the project team. The existing buildings and structures, high volume of pedestrian footpaths and at-grade traffic carriageways and junctions have meant that on-site materials storage and extensive scaffolding are not possible. In such situations, rebar and system formwork structures are often prefabricated off-site and then installed on site at night, with road closures for subsequent concrete pouring. Also, the vertical working spaces are constrained by the existing viaduct, so using equipment such as boring rigs or cranes is not an option. Then, of course, there is a high volume of live traffic during the day, both at viaduct level and at-grade, which makes our available working time very limited indeed. In many ways, we are enjoying the challenges and opportunities to use our specialized engineering skills – and also our expertise in logistics – on this major project which we know, when completed in February 2015, will be appreciated by the very many people who drive along this route on a daily basis. ●

“The nature and location of the scheme have brought some very specific challenges to the project team.”

**TEAM & TECHNOLOGY**

- Owner** – Land Transport Authority of Singapore (LTA)
- Main contractor** – Singapore Piling & Civil Engineering
- Civil & structural engineering consultant** – YWL Engineering
- Technology** – BBR CONA internal
- BBR Network Member** – BBR Construction Systems Pte. Ltd (Singapore)



3





## PENANG SECOND CROSSING, MALAYSIA

Precast segment production

# 100 DAYS AHEAD OF SCHEDULE!

BBR Malaysia was contracted to carry out match-casting of precast segments for the Penang Second Crossing bridge project and completed their task over three months ahead of schedule! Chee Cheong Chang of BBR Malaysia outlines the project.

The Penang Second Crossing provides an additional access bridge to the island of Penang which should reduce the high traffic volume on the existing bridge. The new crossing consists of two bridges – one for traffic going towards the island and the other for traffic heading for the mainland. Each bridge consists of precast box girder segments with external post-tensioning. In total, 8,092 segments were needed for the new 24km bridge. Typical segment dimensions are 14m wide by 4m long by 3.2m deep. By casting against the previously cast segment, the joint matching of shear keys during segment erection can be assured. The other joint surface was formed by a steel bulkhead. The tendon sizes are 19 to 31 strands of 15.2mm diameter. Deviator holes in the deviator segments were formed using reusable formers. For tighter curves, bent steel pipes cast into the concrete are used to deflect the external tendons.

Completed segments were delivered by gantry crane to the barges. The weight of a typical segment was 80t – while individual pier segments weighed in at 110t. The segments were delivered to the working fronts using launching gantries, as the bridge was being erected by the span-by-span method. BBR Malaysia was one of three segment precasters contracted for the task. Segment casting was completed 100 days ahead of schedule – allowing main contractor, UEM Builders(M) Sdn Bhd, to stay well on track with their program. ●

### TEAM & TECHNOLOGY

**Owner** – Public Works Ministry of Malaysia  
**Main contractor** – UEM Builders (M) Sdn Bhd  
**Technology** – Span-by-span precast, BBR CONA external  
**BBR Network Member** – BBR Construction Systems (M) Sdn Bhd (Malaysia)

SEAFORD RAIL BRIDGE, ADELAIDE, SOUTH AUSTRALIA

World's third longest incrementally launched bridge

# EXTRAORDINARY ENGINEERING FEAT

When two teams of specialist engineers met – suspended above a river valley midway across a bridge spanning well over a kilometer in length – it marked the climax of an extraordinary engineering feat.

The new rail bridge spanned the Onkaparinga River and its floodplain, linking two crews who, 20 months previously, had started constructing different sections of bridge at either end of the project. When the two crews shook hands in celebration, they could look back on a unique civil engineering project that had crossed the large river valley creating the longest incrementally launched

bridge in Australia and the third longest in the world.

The rail bridge is the key feature in the 5.7km long passenger railway line extension from Noarlunga to Seaford, a southern suburb on the outskirts of Adelaide. It was commissioned by the South Australian Government under a joint venture arrangement with Thiess MacDow, with Structural Systems in support.



2



1



**Construction sequence**

In order to accomplish the task, Structural Systems and the contractor’s team constructed 22 spans of up to 2.3m in length, cast in steel formwork established at either end of the bridge, then jacked progressively into place. A total of 48 segments, mainly 26.15m long were built this way and pushed using Structural Systems’ specialist bridge launching technology.

Although the bridge was launched continuously from each end, it was temporarily configured as twin structures, later to be released to form seven non-linked sections. This was so that the railway line would have the ability to expand or contract with temperature changes and thereby avoid buckling.

**Engineering Excellence commendation**

Seaford Rail Bridge has been described as one of the most impressive civil construction feats ever undertaken in South Australia. The mammoth 1,123.9m long structure has received an Engineering Excellence commendation. Structural Systems significant contribution to the bridge’s concept and construction methodology was likewise recognized, noting the minimal impact on the environmentally sensitive floodplain. ●



3

- 1 The new Seaford Rail Bridge is the key feature in a 5.7km long passenger railway line extension from Noarlunga to Seaford, South Australia.
- 2 A total of 48 precast segments, mainly 26.15m long were constructed on site and pushed into place using Structural Systems’ specialist bridge launching technology.
- 3 The segments were post-tensioned using BBR VT CONA CMI internal, BBR VT CONA CME external and PT Bars.

**TEAM & TECHNOLOGY**

**Owner** – Government of South Australia, Department for Transport, Energy and Infrastructure

**Main contractor** – Thiess McConnell Dowell Joint Venture

**Designer** – Aurecon

**Technology** – BBR VT CONA CMI internal, BBR VT CONA CME external, PT Bar system, Launching

**BBR Network Member** – Structural Systems Limited (Australia)

PUSENCI FLYOVER, SLOVENIA

Post-tensioning and heavy lifting technology

# ABOVE AND BELOW THE LINE SOLUTIONS

A new flyover has been constructed over railway tracks, allowing traffic to pass above the main line from Ormoz and the old railway crossing ramp to be closed. In a two-part project, BBR Adria has post-tensioned a 183m long flyover and also slid a pedestrian underpass into place – and only a two day railway possession was required.

Construction of the flyover was completed in seven segments – the first, at 37m, was the longest while the remainder were between 21.4 and 29.4m in length. The flyover has eight piers with spans from 15 to 25m long.

Within the same project, a pedestrian subway was also built under the railway tracks next to the flyover. Railway traffic continued during construction and only a two day possession of the tracks was permitted, so the pedestrian subway was fully constructed to one side and slid into place. During the possession, the rails above the final location for the subway were removed, excavation was completed and then the finished underpass was slid into place using PT jacks. When the subway was finally positioned, new tracks were installed above and the railway traffic recommenced. ●



1



2

- 1 The 183m long flyover across the main railway line was completed in seven segments.
- 2 The new underpass was slid into place using PT jacks during a railway possession.

## TEAM & TECHNOLOGY

**Client** – Direction for Roads, Republic of Slovenia

**Main contractor** – SGP Pomgrad – Gradnje d.o.o.

**Designer** – KO-BIRO d.o.o., Maribor, Slovenia

**Technology** – BBR VT CONA CMI internal, sliding

**BBR Network Member** – BBR Adria d.o.o. (Croatia)

## PEDESTRIAN BRIDGE, LESOTHO

Stressing &amp; anchoring technology

# SPECTACULAR STRESSED RIBBON BRIDGE



1 Two long groups of sagging tensioned strands – or ‘bearer tendons’ – are used to suspend the 84 precast concrete segments forming the wafer-thin concrete bridge deck.

## TEAM & TECHNOLOGY

**Owner** – Metalong Authority & Kingdom of Lesotho

**Main contractor** – EXR Construction Lesotho (Pty) Ltd

**Designer** – SSI in association with Jeffares & Green, GWC and DHV

**Technology** – BBR VT CONA CMI internal, BBR VT CONA CMG ground

**BBR Network Member** – Structural Systems Africa Ltd (South Africa)

Lesotho is a landlocked country – completely surrounded by neighboring South Africa – and is now the home to a unique stressed ribbon pedestrian bridge. Sean Kelly of Structural Systems Africa Limited (SSA) explains that the 248.5m long bridge has been constructed over a gorge which is up to 50m deep and 240m wide. When the dam being built downstream is commissioned, the tail water level will completely encase the gorge from abutment-to-abutment – and, without this new bridge, it would be impassable by local people.

The award of this specialist works contract followed earlier post-tensioning services provided by Structural Systems Africa to the main contractor and involving 24 x 20m long post-tensioned precast beams for a six span bridge, about 30km away. The two-span stressed ribbon bridge in Lesotho consists of two groups of sagging tensioned strands – 25 x 15.7mm strands each – which follow a catenary arc from abutment to a central pier to abutment. These two groups of strands – or ‘bearer tendons’ – are used to suspend 84 precast concrete segments which form the concrete deck. The deck is wafer thin when looked at in comparison to the maximum 127.75m span, and is assembled by individually suspending the 2.5m long precast segments on the bearer tendons at the abutment and then shifting them along to their final position. The bearer tendons were tensioned to 42% of Minimum Breaking Load (MBL) before installation of the segments. Their load was then fine-tuned to achieve similar levels in both spans. Each group of 25 strands was made up of 2 x 8-strand and 1 x 9-strand BBR VT CONA CMI tendons to enable the fine-tuning to be carried out on multiple strands at a time, using 300t multistrand jacks. Prior to encasing the bearer tendons in permanent in-situ concrete, additional 2 x 8-strand post-tensioned tendons were installed for stressing after the in-situ concrete reached the required compressive strength. The tendons were 248m long and required stressing from both ends to compensate for wobble effects and friction losses.

In addition to the bearer and post-tensioned tendons, the two abutments required anchoring into the surrounding rock to enable the suspension of the large spans. SSA was also engaged in the preliminary works which involved the installation of 12 x 22-strand permanent ground anchors. This was the first ground anchoring job in Africa for SSA and, with the help of Structural Systems (Civil) in Australia, a high quality product was achieved. The anchors have a MBL of 6,138kN and were proof loaded to 75% of this load, before locking-off at 55% MBL. With a bond length of six meters and free length of 10m, the anchors were assembled on site and lowered into the drill hole by a crane. To ensure an even build-up of stresses in each anchor set, the load in the anchors was increased in 20% MBL increments sequentially, from the inner anchors to outer anchors. ●



## BOTLEK CORRIDOR, ROTTERDAM, NETHERLANDS

Post-tensioning for bridges, ballast blocks & pergola beams

# EUROPE'S LARGEST LIFT BRIDGE

Europe's biggest port, at Rotterdam, continues to expand and infrastructure is being extended and upgraded to meet the future needs of this busy port and industrial complex. The A15 motorway, giving east-west access across the country and beyond, is now being extended and Ron van Dijk of Netherlands-based BBR Network Member, Spanstaal – Ballast Nedam Infra Specialiteiten B.V., describes his company's work in the Botlek Corridor – including how an important element of this €1.5 billion project, the existing Botlek Bridge, will be replaced by a new bridge which, when completed, will be one of the largest lift bridges in the world.

A major shipping bottleneck will be relieved by the realization of the new lift bridge at Botlek, which is being constructed by the A-Lanes A15 consortium – formed by Ballast Nedam, John Laing, Strabag and Strukton – who are responsible for the expansion and subsequent maintenance of the A15 between the Maasvlakte and Vaanplein junction. The project is being carried out as a 'Design, Construct and Maintain' contract with a term of 25 years, thus quality and lifetime considerations are of prime importance.

The current Botlek Bridge is mainly used by hazardous freight which is not permitted to pass through the Botlek Tunnel. The new bridge, being built alongside the existing

bridge, will have two openings for shipping – each around 90m wide and sitting around 14m above the river. The headroom above the river will be twice the height of that afforded by the current bridge – thus, larger vessels will be able to pass underneath without holding up traffic traversing the bridge. Its two sections will also allow ships coming from opposite directions to pass simultaneously. When completed, the new Botlek Bridge will be capable of being raised 31m in a very short time.

Spanstaal, in conjunction with Tensa, has been working on the adjacent structures, including the western access ramp (long spans), pergola beams and trough bridges (short spans).

### FACTS & FIGURES

- **Pergola construction**
  - 924 x ø47 PT bar
  - 202 x BBR VT CONA CMI 2706 tendons
  - 260t prestressing steel
  - 72 x elastomeric blocks (ø350 x 85 and ø850 x 157)
- **Western access ramp**
  - 176 x BBR VT CONA CMI 1906 tendons
  - 280t prestressing steel
- **Bridge counterweights**
  - 72 x BBR VT CONA CMI 1906 tendons
  - 80t prestressing steel



2



3

### Western access ramp

Three access ramps have been built on both sides of the Botlek Bridge. The two outer ones for through-traffic and the middle one for the access ramp. The ramps were built in three phases and one of the most notable features of the post-tensioning here is that we executed it using couplers. In the execution of this part of the project, we used 176 BBR VT CONA CMI tendons and 280t of prestressing steel. On the east side of these long spans are four trough bridges each 37m long and post-tensioned with 12 x 2206 strand tendons.



4

### Pergola construction

Traffic on the Botlek Bridge will cross the traffic exiting the Botlek Tunnel. Thus, pergola structures, made of prefabricated I-beams, are being built to connect the new bridge over the tunnel entrance ramps to the A15.

During one weekend, we lifted and installed the 36 prefabricated 37-48m long, 2.8m high I-beams – weighing up to 238t each – into their final locations where they rest on 72 elastomeric blocks. The beams are linked together by two rods and the gaps between the beams were filled with grout. After every two beams had become completely monolithic with each other, the beams were post-tensioned using 10 to 12 CONA CMI tendons per grid. Then we grouted all the transverse tendons with a special grout mixture.

All of this work had to be carried out above live traffic. For this, we used three dense scaffolding grids hung from the tunnel walls so as not to impede the traffic flow beneath.

### Counterweights

The new bridge will be the biggest lift bridge in Europe and, therefore, very heavy ballast counterweights are needed – the two steel bridge decks weigh 7,200t. The four 2.5t blocks – two for each bridge deck – will each be post-tensioned with 18 CONA CMI tendons. Nine tendons will be secured, using CONA CMI SP anchors, to the steel plates on two opposite sides at the base of each block.

### Specialist works

Spanstaal is also responsible for specialist works involved in the construction of various other access bridges on the Botlek Corridor, some of which has involved the supply of 900 elastomeric blocks with epoxy and the production and installation of 600m of expansion joints.

When the new bridge is commissioned in early 2016, demolition of the old bridge will begin and finally the flow of both shipping and road traffic will be eased. ●

- 1 Pergola structures, made of prefabricated I-beams, are being built to connect the new bridge over the tunnel entrance ramps to the A15.
- 2 Botlek Bridge, Western Access Ramp, long spans – continuous post-tensioning tendons are placed on the deck near the construction joint, coupling cables have been stressed.
- 3 The precast prestressed I-beams for the pergola structures – each beam weighing up to 238t – were post-tensioned using 10 to 12 BBR VT CONA CMI tendons per grid.
- 4 The two steel decks of the new lift bridge weigh 7,200t and require four 2.5t post-tensioned ballast blocks.

## TEAM & TECHNOLOGY

**Owner** – Rijkswaterstaat

**Main contractor** – A-Lanes A15 Consortium (Ballast Nedam, John Laing, Strabag & Strukton)

**Technology** – BBR VT CONA CMI internal, PT bar, Bearings, Expansion joints

**BBR Network Member** – Spanstaal – Ballast Nedam Infra Specialiteiten B.V.

BATINAH EXPRESSWAY, SULTANATE OF OMAN

Testing & post-tensioning works

# LONGEST BRIDGE TENDONS IN OMAN

Since Structural Systems began operations in the Middle East, the team has provided technology and expertise for the post-tensioning of over 50 bridges in the region. Now, they are working on a major bridge project in Oman, Warwick Ironmonger takes up the story.

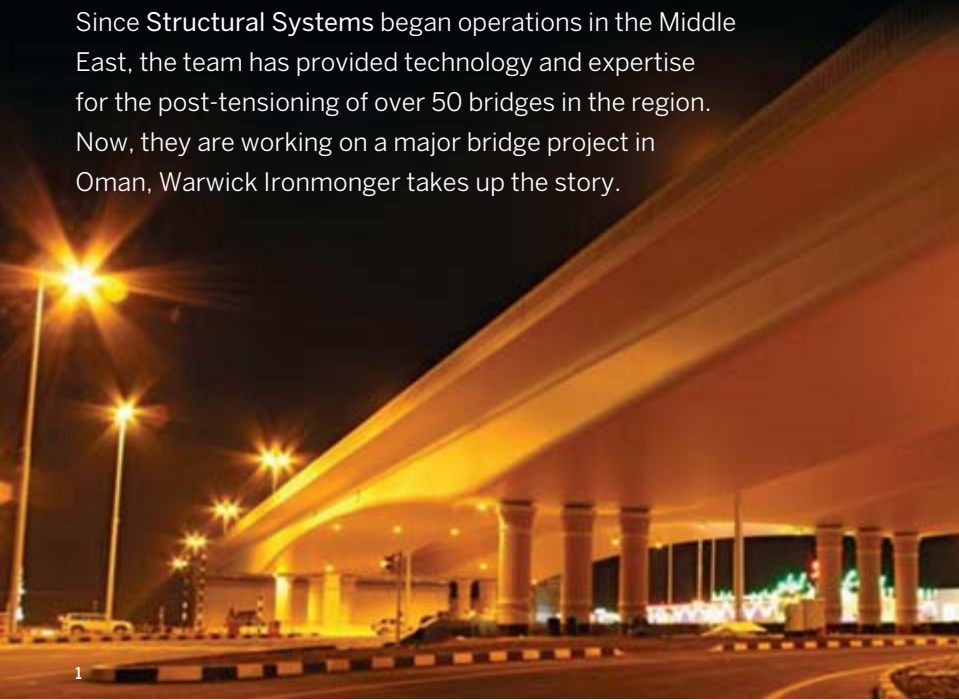

1

The Batinah Expressway Package-1 project for the Ministry of Transport and Communication (MOTC) is the first significant bridge project – involving nearly 1,400t of prestressing steel – secured by Structural Systems in Oman.

Extensive testing, comprising of both static load and load transfer tests, was undertaken in accordance with project specifications to demonstrate the compliance of the BBR VT CONA CMI systems to the requirements of AASHTO LRFD Bridge Construction specification for highly aggressive environments. For further details, see Page 68.

The Barka Interchange, forming part of the Batinah Expressway Package-1 project, is located at Barka near to Muscat. It has two structures – the East Bridge and the West Bridge. The length of each bridge is 160m over three continuous spans. The center span is 70m and both end spans are 45m each. Each bridge is a three cell post-tensioned box girder structure, with depth varying from 2m to 4m.

For the Barka Interchange, we used the BBR VT CONA CMI 4206 post-tensioning system and almost 260t of prestressing steel. The interchange is believed to feature the longest single bridge tendons – around 162m long – in Oman.

With these significant bridges now under their belt, Structural Systems have now managed to secure further bridges works in Oman including the Murray to Al Ayn Bridges and the Al Jazeera Bridges at Sur, both with MOTC, and the Oman Convention and Exhibition Center civil works for OMRAN, the company set up by the Government of Oman to deliver major projects and to manage assets and investments of the tourism sector. ●

- 1 For the Batinah Expressway's Barka Interchange project, BBR VT CONA CMI post-tensioning systems were tested to demonstrate compliance with the requirements of AASHTO LRFD Bridge Construction specification for highly aggressive environments.
- 2 The 162m long post-tensioning tendons used on the project are believed to be the longest single bridge tendons ever used in Oman.

## TEAM & TECHNOLOGY

**Owner** – Ministry of Transport & Communication  
**Main contractor** – Galfar  
**Consultant** – Parsons  
**Technology** – BBR VT CONA CMI internal  
**BBR Network Member** – Structural Systems Limited (Oman Branch)



2



## POST-TENSIONED SLAB &amp; BEAM SOLUTIONS, POLAND

Optimizing structures with versatility and strength

# EARLY INVOLVEMENT FOR BEST SOLUTION

Structures, such as the new Business Garden offices in Warsaw, owe much to the expertise and ingenuity of BBR Polska's dedicated team of engineers who are focused on developing and applying leading-edge post-tensioning solutions for buildings. Bartosz Lukijaniuk, Design Coordinator, of BBR Polska talks us through some recent projects which have offered clients and their main contractors some real benefits.

**1** The new Business Garden office complex in Warsaw consists of two buildings – a further five buildings will be constructed in a second phase. The complex features post-tensioned slabs throughout – even in the underground car park – and these cover a total area of 52,000m<sup>2</sup>. We used the BBR VT CONA CMM unbonded system which best suited the project needs.

The BBR Polska team had to meet a number of challenges. There were long spans of up to 11.4m and some difficult architectural shapes – most of the slabs were unique. We were also targeting low material consumption rates and, for a typical slab, mild steel consumption was around just 11kg/m<sup>2</sup>. Without doubt, our early involvement in the project – right from the conceptual design stage – helped to deliver exactly what the client wanted. ►

“Where longer spans are designed by architects, post-tensioned beams are the ideal solution for minimizing beam size – and also construction costs.”

**2 Structural optimization**

Another example of a building for which we adopted an unbonded post-tensioning approach to the slabs can be found in the public sector – at Warsaw Medical University.

For this project, post-tensioning technology was chosen as an alternative solution to the original design which used reinforced concrete slabs with void forming ‘plastic bubbles’ to make the slabs lighter. With our CONA CMM post-tensioned solution, the 2,800m<sup>2</sup> of slabs were not only thinner but consumption of mild reinforcement was much lower.

Here, we joined the project team with the express purpose of bringing our ideas for optimizing the structure to the table.



2

**3 Achieving long cantilevers**

The architect’s vision for a new luxury residential development in Warsaw included the construction of balconies with long cantilevers of up to 4.6m – uneconomical to design using only reinforced concrete. Again, we were brought into the project team from the earliest concept stage and were thus able to offer advice on a structural solution to fulfill the architectural vision. Slabs were post-tensioned with BBR VT CONA CMM unbonded post-tensioning tendons.

**4 Reduced materials consumption**

Meanwhile, in Wroclaw, the structural solution for part of a multi-purpose building generated spans of around 10m – a one span slab with a small cantilevered balcony. With our help, the use of flat bonded BBR VT CONA CMF post-tensioning tendons within a 350mm thick slab was chosen as the best solution for this structure. An additional advantage offered by our solution was low consumption of mild reinforcement – at a rate of only around 6kg/m<sup>2</sup>.



3



4



5

- 1 Business Garden offices, Warsaw – long spans and complex architectural shapes, as well as low material consumption rates were achieved through early project involvement and the post-tensioning expertise of the BBR Polska team.
- 2 Warsaw Medical University – another early involvement project where our alternative post-tensioned approach to construction produced thinner slabs and a lower consumption of mild reinforcement.
- 3 Residential building, Warsaw – with early advice and BBR VT CONA CMM post-tensioning, we helped to fulfill the architect's vision for this new luxury development.
- 4 Multi-purpose building, Wrocław – flat bonded BBR VT CONA CMF post-tensioning was used to produce one span slabs with small cantilevered balconies.
- 5 Korona Kielce shopping center – beams post-tensioned using the BBR VT CONA CMI bonded system were constructed for the main access footbridge.
- 6 Silesian Museum, Katowice – BBR VT CONA CMI and CMM post-tensioning technology was chosen here to minimize the beam size over the main two level exhibition halls and three levels of underground parking.



6

## 5 6 PT beams make clear spaces

Where longer spans are designed by architects, post-tensioned beams are the ideal solution for minimizing beam size – and also construction costs. One such example of a PT beam solution was executed by BBR Polska for a shopping center in the city of Kielce. BBR VT CONA CMI post-tensioned beams were used in the footbridge forming the main access to the shopping center. The BBR Polska team offered a solution based on BBR VT CONA CMI bonded post-tensioning with multistrand tendons. Another interesting example showing the benefits of post-tensioning for long beams with heavy load capacity was at the Silesian Museum in Katowice where CONA CMI and

CMM post-tensioning technology was chosen to minimize the beam size. Post-tensioned beams were designed and installed over the main two level exhibition halls and three levels of underground parking. The beams over the exhibition halls are about 25m long – one span with a 3m cantilever – while the parking slab beams are 32m long and create two spans. No matter what the purpose of the building, the use of a post-tensioned approach to construction can help to create great usable space, fulfill architectural visions and optimize both materials and costs. The team at BBR Polska has enjoyed these challenges and stands ready for even more challenging early stage involvement projects. ●

## TEAM & TECHNOLOGY

- 1 **Business Garden, Warsaw**  
**Owner** – Wiśniowy Office Park / Swede Center  
**Main contractor** – Hochtief Polska  
**Architect** – APMD  
**Designer** – ARCADE Polska (structural), SDS & BBR Polska (post-tensioning)  
**Technology** – BBR VT CONA CMM monostrand  
**BBR Network Member** – BBR Polska Sp. z o.o. (Poland)
- 2 **Medical University, Warsaw**  
**Owner** – Medical University, Warsaw  
**Main contractor** – Budimex S.A.  
**Architect** – Kontrapunkt V-projekt  
**Designer** – Kontrapunkt V-projekt (structural), POMOST & BBR Polska (post-tensioning)  
**Technology** – BBR VT CONA CMM monostrand  
**BBR Network Member** – BBR Polska Sp. z o.o. (Poland)
- 3 **Residential building, Warsaw**  
**Owner** – Dom Development  
**Main contractor** – Eiffage Polska Budownictwo  
**Architect** – Maka.sojka.architekci  
**Designer** – ARBO (structural), SDS & BBR Polska (post-tensioning)  
**Technology** – BBR VT CONA CMM monostrand  
**BBR Network Member** – BBR Polska Sp. z o.o. (Poland)
- 4 **Multipurpose building, Wrocław**  
**Owner** – Wisner Enterprise  
**Main contractor** – Karmar S.A  
**Architect** – Mackow Pracownia Projektowa  
**Designer** – PB Stalbet (structural), SDS & BBR Polska (post-tensioning)  
**Technology** – BBR VT CONA CMF flat  
**BBR Network Member** – BBR Polska Sp. z o.o. (Poland)
- 5 **Korona Kielce shopping center, Kielce**  
**Owner** – Church Land Development  
**Main contractor** – SPS Construction Sp. z o.o.  
**Architect** – Bose International Planning & Architecture  
**Designer** – Bartels Polska & Chodor Projekt (structural), K2 Engineering & BBR Polska (post-tensioning)  
**Technology** – BBR VT CONA CMI internal  
**BBR Network Member** – BBR Polska Sp. z o.o. (Poland)
- 6 **Silesian Museum, Katowice**  
**Owner** – Silesian Museum  
**Main contractor** – Budimex S.A.  
**Architect** – Riegler Riewe Architekten  
**Designer** – Firma Inzynierska STATYK (structural), SDS & BBR (post-tensioning)  
**Technology** – BBR VT CONA CMI internal, BBR VT CONA CMM monostrand  
**BBR Network Member** – BBR Polska Sp. z o.o. (Poland)



1



2

PUBLIC CAR PARK, VARAZDIN, CROATIA

Post-tensioning creates large spans

# LARGE SPANS ENHANCE UNDERGROUND PARKING



3

Famed for its baroque architecture, Varazdin in northern Croatia has long been a major center for tourism and commerce. It is here, below Kapucin Square, recounts Kresimir Bogadi of BBR Adria, that an acclaimed new 443-space underground city center car park has been created.

Close to Varazdin Park, the railway station and all the City's major attractions, the new underground garage has two below grade levels with a total area of 12,370m<sup>2</sup> which have been designed in a 77m by 80m layout. At five meter intervals, there are beams running across five column spans 16m each. The lower slab will only be loaded with traffic and was designed as a 160mm slab with 500 x 600mm beams laid in one direction at five meter intervals. However, the upper slab has to carry greater load (33.5kN/m<sup>2</sup>) and was therefore designed as a 240mm thick slab with 750 x 900mm beams. Tendons in the greater span direction are located inside the beams, while in the perpendicular direction they are located in the slab.

The overall quality and comfortable parking experience afforded is an advantage of being able to remove the middle columns in the 16m span direction, through the adoption of a post-tensioned approach.

## TEAM & TECHNOLOGY

- Client** – Crtorad d.o.o.
- Main contractor** – Zagorje Tehnobeton d.d.
- Designer** – K.A. Biro d.o.o.
- Technology** – BBR VT CONA CMM monostrand
- BBR Network Member** – BBR Adria d.o.o. (Croatia)

### Optimal solution

There are several reasons that unbonded post-tensioning was chosen as the optimum solution for this project. Firstly, there was positive experience in terms of bridging these spans from the Tuskanac underground car park in Zagreb – a project carried out by BBR Adria in 2008. Next, the high water table demanded shallow excavation – and consequently, construction could only be carried out with shallow slabs. The third reason was the time schedule – project execution during the winter, with a tight time schedule, dictated use of 15 x 80m working segments. Thus, in the direction of span beams, a 15 x 80m slab was concreted and stressed in one go – thanks to unbonded technology, the friction losses could be kept to a minimum. Only the first slab above foundation level was subsequently connected with the side walls after stressing, while the upper slab was cast and stressed along with the side walls. This approach resulted in an absence of shrinkage and temperature cracks, despite a large segment length of 80m. Above the car park's upper slab, on top of a one meter bank layer, a decorative city square was constructed and landscaped.

### Safe, easy and attractive to use

The new car park is characterized by its great all-round visibility – with only minimal visual barriers – which, together with the wide access ramps and their gentle gradients, make this new facility safe, easy and attractive to use.

As a result of the positive feedback from investors and clients, BBR Adria is strongly promoting this large span approach to building layout as a standard 'way to go' in the region. Meanwhile, the quality and optimal solution offered by this type of building have officially been recognized by the civil engineering profession – the project's designers were presented with the 2013 'Kolos' Award by the Croatian Chamber of Civil Engineers for a remarkable achievement in the construction category. ●

- 1 Installation of BBR VT CONA CMM monostrand unbonded post-tensioning under way – this system was chosen as there was good earlier experience locally and the system promoted a particularly fast construction time.
- 2 Post-tensioning allowed the creation of large spans at the new city center underground car park in Varazdin, Croatia.
- 3 Adopting a post-tensioned approach allowed removal of middle columns in the 16m span direction – and affords an overall quality and comfortable parking experience.

## UNDERGROUND CAR PARK, WROCLAW, SILESIA, POLAND

Material & cost savings with post-tensioning

# OPTIMIZED CONSTRUCTION & BUDGET



BBR Network Member, BBR Polska has recently been involved in a project which clearly highlights the benefits of early collaboration between main and specialist contractors and shows how PT technology used in slabs saves construction materials and allows optimization of other structural elements. Design Co-ordinator, Bartosz Lukijaniuk, outlines the realization of this important new underground car park right next door to Wrocław's Centennial Hall.

The underground car park is designed for around 800 cars, over two underground levels, and covers a total area of 7,200m<sup>2</sup> – with some 12,700m<sup>2</sup> of post-tensioned slab.

Our early selection by the main contractor meant we could contribute to concept design and project specification. The main contract includes design, construction and maintenance of the car park for several years – so our client was especially keen to use structural solutions and technologies offering problem-free maintenance. The client chose BBR technology because, among other benefits, post-tensioning promotes reliable slab performance – especially in relation to reduced cracking. Also, our solution offered low construction material consumption. The rate of consumption of reinforced concrete was 12kg/m<sup>2</sup> and for post-tensioning this was reduced to 3.5kg/m<sup>2</sup> with a slab thickness of 250mm for spans of 7.85 x 7.85m.

Our post-tensioned slab solution saved 12% of the construction costs compared with traditional reinforced concrete. In addition, our solution minimized the overall structural thickness – which was actually a crucial issue. By using our PT solution, we reduced the overall height of the structure by 700mm – again, compared with taking a traditional reinforced concrete approach. This structural optimization reduced excavation needs by about 5,000m<sup>3</sup> too. ●

### TEAM & TECHNOLOGY

**Owner** – Hala Ludowa

**Main contractor** – Budimex S.A.

**Designer** – VROA Architekci and CH+ Architekci (architectural), Bartels Polska (structural), POMOST & BBR (post-tensioning)

**Technology** – BBR VT CONA CMM monostrand

**BBR Network Member** – BBR Polska Sp. z o.o. (Poland)

PROJECT HIGHLIGHTS

Brief overview of five BBR Network projects in Singapore

# SPACIOUS AND STRONG IN SINGAPORE

With space always at a premium on the island of Singapore, it is no surprise that owners, developers and users of buildings of all types are keen to embrace the benefits of post-tensioning. Five recent schemes here demonstrate the advantages of post-tensioned beams and slabs, not only for delivering greater floor-to-ceiling heights, but also higher floor loadings – and maximized opportunities for expansive column-free spaces.

## TEAM & TECHNOLOGY

- 1 Owner** – Singapore Workforce Development Agency (WDA)  
**Main contractor** – Greatearth Construction Pte. Ltd  
**C&S Consultants** – Beca Carter Hollings & Ferner (SE Asia) Pte. Ltd  
**Technology** – BBR CONA internal, BBR CONA flat  
**BBR Network Member** – BBR Construction Systems Pte. Ltd (Singapore)

---

- 2 Owner** – Ministry of Education Singapore  
**Main contractor** – Hytech Builders Pte. Ltd  
**C&S Consultants** – Beca Carter Hollings & Ferner (SE Asia) Pte. Ltd  
**Technology** – BBR CONA internal, BBR CONA flat  
**BBR Network Member** – BBR Construction Systems Pte. Ltd (Singapore)

---

- 3 Owner** – EL Development Pte. Ltd  
**Main contractor** – Evan Lim & Co. Pte. Ltd  
**C&S Consultants** – Fong Consult Pte. Ltd  
**Technology** – BBR CONA internal, BBR CONA flat  
**BBR Network Member** – BBR Construction Systems Pte. Ltd (Singapore)

---

- 4 Owner** – Wee Hur (Kaki Bukit) Pte. Ltd.  
**Main contractor** – Wee Hur Construction Pte. Ltd  
**C&S Consultants** – LSW Consulting Engineers Pte. Ltd  
**Technology** – BBR CONA internal, BBR CONA flat  
**BBR Network Member** – BBR Construction Systems Pte. Ltd (Singapore)

---

- 5 Owner** – Ascendas Pte. Ltd  
**Main contractor** – Nakano (Singapore) Pte. Ltd  
**C&S Consultants** – Ronnie & Koh Consultants Pte. Ltd  
**Technology** – BBR CONA internal, BBR CONA flat  
**BBR Network Member** – BBR Construction Systems Pte. Ltd (Singapore)



**1 National Continuing Education and Training (CET) East Campus, Paya Lebar**  
 A newly completed eight storey teaching facility, the CET Campus East offers industry skills training and also provides horizontal training programs, covering employability skills and service excellence. In addition, CET East Campus will also host short quality CET programs, such as master classes, professional development programs and workshops.



**2 New Primary School, Bukit Panjang Site 16**  
 Winning the coveted BCA Green Mark Platinum Award, the new school consists of three blocks of five to six storey teaching facilities, one block containing a multi-purpose hall – with a rooftop football field – and other ancillary buildings.



**3 Eldix @ Sungei Kadut Planning Area**  
 This 12-storey ramp-up – featuring a delivery ramp – multi-user industrial building is located within the Mandai Estate, northwestern Singapore.



**4 Premier @ Kaki Bukit**  
 This is a flexible blend of eight story 'ramp up' and nine storey flatted, industrial development aimed at expanding and aspiring entrepreneurs. By adopting a post-tensioned approach to the scheme, the development offers high ceilings and a column-free layout promoting better space utilization, as well as allowing direct container access for ramp-up units to enhance business efficiency.



**5 8B @ Admiralty, Admiralty Street**  
 This multi user light industrial scheme in northern Singapore features eight post-tensioned floor levels offering high floor loadings and excellent ceiling heights, as well as dedicated loading bays and post-tensioned access ramps for trucks to every floor.



## MUHARRAQ SEEF MALL, BAHRAIN, UNITED ARAB EMIRATES

Post-tensioning for floor slabs

# BAHRAIN'S NEWEST MALL

As Bahrain's new Muharraq Seef Mall opens its doors to the general public, Warwick Ironmonger of BBR Network Member, NASA Structural Systems LLC, reflects on the challenges presented by this major project – one of many building projects carried out during the company's 15 years in the Middle East.

The Muharraq Seef Mall is a BD15.65m project situated between the Muharraq Club and the Arad Fort in Bahrain, facing onto the newly constructed corniche and bay. The mall has been constructed over two retail floors offering approximately 30,000m<sup>2</sup> of retail space with ample parking underneath on the ground floor. The project also includes an open air amphitheater that will be used for public and cultural events. Previous involvement on similar projects – including a nearby mall on the Muharraq Island and the 162,000m<sup>2</sup> Bur Juman Expansion project in Dubai – along with sound technical support at tender stage,

resulted in the award of post-tensioning works for this project. Our role here was to post-tension the suspended floors, typically of 13.5m x 9m floor spans involving 300t of prestressing steel. By adopting a PT approach to the public areas, wide open spaces have been achieved which will not only enhance consumer experiences, but will also offer flexibility should the client require structural changes at some later stage. Our reputation for providing post-tensioning and other specialist services for buildings has grown in the region, often as a result of our first class performance on infrastructure schemes. To date, we have provided technology and expertise for over 200 buildings, 19 storage tanks and 50 bridges throughout the Middle East. ●

### TEAM & TECHNOLOGY

**Owner** – Muharraq Mall Company  
**Main contractor** – Almoayyed Contracting  
**Technology** – BBR CONA flat  
**BBR Network Member** – NASA Structural Systems LLC (United Arab Emirates)



## CONCERTO NORTH KIARA CONDOMINIUM, KUALA LUMPUR, MALAYSIA

Post-tensioned transfer slab

# WINNING ALTERNATIVE DESIGN

When time and costs – as well as achieving a challenging design concept – were critical, BBR Construction Systems Malaysia produced a contract-winning alternative design for the client, who was also the main contractor. Chuen Lin Lee, Design Engineer, tells the story.

Concerto North Kiara is a new condominium consisting of three high rise residential blocks above a podium containing four car parking levels. The unique design – resembling a piano keyboard – results in high drops in floor level which contribute to the complexity in structural design and detailing. The transfer floor was originally designed with a 2,100mm deep beam and slab system. We redesigned it with a post-tensioned slab to support the load-bearing shear walls which in turn support 30 floors above. A typical post-tensioned slab is 1,400mm thick and transfers the loads to columns on an 8m x 8m grid. Our client, the main contractor, had secured this project based on the benefits and cost reductions resulting from our alternative design. Time was critical as the foundations had been built, while the design using our alternative post-tensioned slab was still in progress. Various high drops of up to 700mm – for landscaped gardens – with few column supports below, made it difficult to achieve the required load transfer through the

structural PT slab to the columns. We overcame this problem by increasing the thickness of the PT slab by 150mm at several locations, making the structure stiffer and distributing the loads through selected columns. By placing the two-way tendons with selected profiles at the required locations, load balancing between the gravity loads and prestressing uplift forces was achieved.

While the main contractor is benefitting from the shallow and simpler formwork and the shorter erection time, the owner will also benefit from the flat and more attractive soffit of the transfer floor. The post-tensioned slab was designed for two stage casting with two groups of 1205 BBR CONA internal tendons. After first stage concreting had achieved a 35N/mm<sup>2</sup> strength, the first group of tendons were stressed to enable the second stage casting. Thus, the props to support the wet concrete weight and backprops required for floors below had been halved, providing savings to the client. ●

### TEAM & TECHNOLOGY

**Owner** – B C B Berhad  
**Main contractor** – Awangsa Bina Sdn. Bhd.  
**Prestressing contractor** – BBR Construction Systems Malaysia  
**Technology** – BBR CONA internal  
**BBR Network Member** – BBR Construction Systems (M) Sdn Bhd (Malaysia)

## ELEPHANT HOUSE ROOF, ZÜRICH ZOO, SWITZERLAND

Post-tensioning of ring beam

# TRUMPETING TRIUMPH

The centerpiece of Zurich Zoo's 10,000m<sup>2</sup> Kaeng Krachan Elephant Park is a circular concrete elephant house with a striking curved wooden roof structure. Fabian Persch of BBR Network Member Stahlton AG reveals the challenges behind the realization of this unusual structure.

The giant roof with an area of 6,000m<sup>2</sup> and 85m in diameter acts as a self-supporting shell structure, whose loads are transferred via a post-tensioned concrete ring beam to local roof foundations. The roof's shape is irregular in order to have a natural, random appearance and to meet the building's utilization requirements. The 270m long ring beam was the most complex element of the support structure. It follows the uneven behavior of the roof edge and, while bridging spans of up to 40m with only very small deflections permitted, the beam is intended to be thin and invisibly integrated in the roof. This could only be achieved by using post-tensioning. The aim of the concrete structure's design was to integrate all concrete members, such as rain water tanks or stables, for transferring the roof load – and thus avoid

additional elements as far as possible. The ring beam transfers the roof loads through a limited number of shear walls to the roof foundations which are anchored by piles to resist vertical load and by permanent ground anchors for horizontal load.

It is essential for the roof's stability that the shear walls should only permit very small horizontal movements. Thus, each wall is prestressed with a vertical post-tensioning tendon. To withstand the design loads, as well as to act as a tension flange in accidental design situations – such as the failure of ground anchors and hence the horizontal support of an abutment zone – the ring beam itself is prestressed with nine post-tensioning tendons with lengths of up to 120m and a prestressing force of 190t per tendon.

- 1 Artist's impression of the finished Elephant House at Zurich Zoo, Switzerland.
- 2 Reinforcement and post-tensioning tendons were installed in a 'wooden channel' which was subsequently closed, filled with self-compacting concrete and became an integral part of the structure.



1





2

The tendon layout is three-dimensional – the cables are arranged so that, vertically, the ring beam lifts the roof in the spans and, horizontally, it is tied to the wall abutments. Two tendons were always arranged in parallel to avoid twisting of the ring beam. Due to the sophisticated geometry of the structure, the position of the tendons and the prestressing niches had to be specified and measured to millimeter accuracy.

Reinforcement and post-tensioning tendons were installed in a 'wooden channel' that when subsequently closed with shuttering became a 'wooden pipe' and was filled with self-compacting concrete. The lowest layer of the multi-layer wooden roof served as the soffit formwork and, together with the shuttering and the formwork sides, was also left in the structure.

After staged stressing of the tendons, the roof – so far supported by falsework – was lowered and the loads transferred to the ring beam and foundations, respectively. Structural deflections were monitored with fiber-glass sensors, such that comparisons could be made between the calculated and actual forces / moments in the ring beam. ●

## TEAM & TECHNOLOGY

**Client** – Zurich Zoo  
**Main contractor** – Landolt AG  
**Designer** – Walt + Galmarini  
**Technology** – BBRV wire  
**BBR Network Member** – Stahlton AG (Switzerland)

## FOUNDATION SLAB FOR STONE CRUSHING BUILDING, LA ROCHELLE, FRANCE

Crack-free post-tensioned ground slab

# CRUSHING VICTORY

Holcim France – part of the Swiss group, Holcim Ltd – is constructing a new finishing and distribution center in south western France. The project, known as Ciments de La Rochelle, will create a cement manufacturing and packaging center in the heart of the city's maritime port. BBR Network Member, ETIC, was called upon to provide post-tensioning services for one of the site's key building complexes. Guillaume Wastiaux, Sales Manager for the French market, takes up the story.

This overall project was conceived to support the strong growth in construction and public works activities in the west of France. The new plant will undertake the mechanical crushing and mixing of raw materials and packaging of the finished product for distribution. When completed, the site will accommodate seven zones – raw material storage silos, raw material mixing tower, crushing and drying complex, cement and hydraulic binder storage silos, packaging building, storage facility, plus an administration building with a laboratory and offices. Our role has been to provide post-tensioning for the massive 20 x 20 x 10.5m post-tensioned floor slab of the crushing building. As the slab will carry the enormous load of a stone crushing machine – crucial to the plant's operations – the client naturally required an approach which would minimize cracking.

We supplied and installed horizontal post-tensioning using 12 BBR VT CONA CMI BT 2706 tendons and vertical post-tensioning with 126 x 50mm diameter PT bars.

While the PT bars were prefabricated in the ETIC workshop, we installed the CONA CMI tendons on site using the strand-by-strand method and then stressed and grouted them with cement. It took our team just two weeks on site to complete the work. ●

## TEAM & TECHNOLOGY

**Owner** – Holcim  
**Main contractor** – ERC HARRANGER  
**Technology** – BBR VT CONA CMI internal, PT bar  
**BBR Network Member** – ETIC S.A. (France)





1



2

THE PARABOLA, LONDON, UK

Post-tensioned slab design & installation, specialist heavy lifting techniques

# REVIVING A BOLD STATEMENT

“We are using the BBR VT CONA CMF and CMI 1206 systems with both fixed and movable couplers to allow continuity of pre-stress across the construction joints.”

A redevelopment scheme based around a prominent former public building in Kensington, London will see the revival of an iconic structure, along with the creation of unique museum space and new residential accommodation. Richard Gaskill of local BBR Network Member, **Structural Systems UK Limited**, takes us through the project’s history and outlines the construction challenges.

The Parabola – the former Commonwealth Institute building – had been neglected for nearly 10 years before it was acquired by developers Chelsfield Partners. Their vision is to bring life back to the listed building which has a quirky saddle-shaped structure at its heart. The Parabola – accommodating The Design Museum – will become the centerpiece in a development designed to complement the ingenuity that was the basis of its original creation.

The planning brief called for the preservation of the main structure – a listed building – for use as an art gallery with a greater integration of the gardens into Holland Park. After an architectural competition to explore the best design and practice, much discussion with English Heritage, the local authority and other parties, planning consent was given in September 2009 and construction commenced on site in 2012.

**History & planning**

Completed in 1962, on a 3.25 acre site fronting onto Kensington High Street, The Parabola’s copper clad hyperbolic paraboloid roof has been described as a ‘bold statement’ back then. The striking roof was born of the architect’s desire to create a ‘tent in the park’ – half of the roof was concrete, whilst the other half was traditionally built.

**PT design & installation**

Structural Systems’ role is to provide post-tensioning design and installation expertise for the floor slabs of the three new residential buildings and to apply specialist jacking services techniques for the support of the iconic roof of The Parabola to enable the existing floors to be demolished and rebuilt beneath it.

1 General view of Block B – PT slabs under construction using BBR CONA CMF BT 3 and 4 strand tendons.  
 2 View of parabolic roof structure to Block D, with post tensioned Block C undergoing fit-out work in the background.



## AIR FORCE MUSEUM OF NEW ZEALAND, WIGRAM, CHRISTCHURCH

Post-tensioned concrete floors

# GROUNDING IN EXCELLENCE

Growing demand for high-performance post-tensioned concrete floors continues to keep the BBR Contech team busy. One recent project required the provision of strong floors with attractive finishes capable of holding the weight of aircraft on display at the Air Force Museum of New Zealand.

Levels 1 and 2 of the structure beneath the roof of the existing Institute (Block D) are being installed using post-tensioned concrete, as are the new buildings on the site – Blocks A, B and C. We are using the BBR VT CONA CMF and CMI 1206 systems with both fixed and movable couplers to allow continuity of pre-stress across the construction joints.

### Supporting the roof

Achieving suitable support for the roof was logistically and technically difficult. It required a combination of hydraulic jacking, flat jacking and bar jacking – in association with an extremely complex temporary works solution involving a considerable amount of steelwork.

The original design of The Parabola incorporated the latest techniques of that time and used lightweight construction to produce a building that was functional with minimal resources. The inclusion of the three apartment buildings along with The Design Museum will again reflect contemporary construction techniques and produce a scheme which is energy efficient, easy to access and is complemented by its landscaped surroundings. ●

### TEAM & TECHNOLOGY

**Owner** – Chelsfield Partners

**Main contractor** – MACE

**Architect** – OMA

**Technology** – BBR VT CONA CMI internal, BBR VT CONA CMF flat, Heavy lifting, PT bar, MRR range

**BBR Network Member** – Structural Systems UK Limited (UK)



The Museum is home to a superb collection of military aviation memorabilia, fully restored aircraft, such as the de Havilland Vampire, Supermarine Spitfire and P-51 Mustang, to medals and parachute-silk wedding dresses. In February 2013, the Museum celebrated a major milestone – the official opening by the Governor-General of a NZ\$15 million, 6,500m<sup>2</sup> extension designed by Warren and Mahoney. The new 'Technology Center' – which effectively doubles the Museum's original size – includes an elegantly spacious, hangar-styled display gallery, a large restoration area and a number of workshops.

BBR Contech was involved in two floors in the Museum. The first was the floor in the display gallery – a 200mm-thick, 4,200m<sup>2</sup> expanse of post-tensioned, water-pipe-heated concrete, which was poured in two consecutive days. The floor has the strength to hold the 130kN axle load of a

Bristol Freighter, with a smooth finish and comfortable ambient temperature to suit the room's role as a venue for displays and public functions.

The second post-tensioned floor, covering 983m<sup>2</sup>, was installed in the workshop area. Together, these two projects have helped the Museum to improve both its public face and the working environment it provides for those responsible for its fascinating restoration projects. ●

### TEAM & TECHNOLOGY

**Client** – RNZAF Museum Trust Board

**Architect** – Warren and Mahoney

**Main contractor** – Mainzeal Property & Construction

**Flooring contractor** – Conslab Ltd

**Engineer** – Alan Reay Consultants

**Technology** – BBR CONA flat

**BBR Network Member** – BBR Contech (New Zealand)

PRZEMYSŁ BRIDGE, SOUTHERN POLAND

Official opening by Prime Minister

# SYMBOL OF PROGRESS

The new Przemysł Bridge was opened by Prime Minister Donald Tusk, on the eve of Polish Independence Day – and in the full glare of the nation's media.

In his speech, Prime Minister Tusk said:

“The fact that today we are standing underneath these modern pylons, this modern bridge is a symbol of the distance Poland has covered.”

BBR Polska was represented at the opening ceremony by CEO Jan Piekarski.

The project featured incremental launching of the steel bridge deck and installation of BBR HiAm CONA stay cables.

The bridge, which is part of the Przemysł Ring Road, will alleviate traffic congestion in the city center and allow easier access to the border crossing with Ukraine. ●

## TEAM & TECHNOLOGY

**Owner** – Local Management of District Roads, Przemysł

**Main contractor** – Mota-Engil Central Europe S.A.

**Designer** – Promost Consulting

**Technology** – BBR HiAm CONA stay, Incremental launching

**BBR Network Member** – BBR Polska Sp. z o.o. (Poland)

## NEW ACCESS FOR EUROPEAN SCHOOL, MAMER, LUXEMBOURG

Stay cable technology using stainless steel ducting

# FLYING ENTRANCE FOR SCHOOL

When the stunning new flyover with its unique geometry at Mamer, in Luxembourg, was opened in late 2013, peak time commuters and students alike must have sighed with relief. Claude Néant of BBR Network Member, ETIC, provides some insights into this unusual and very striking project.



1

The N6 highway between Bertrange and Mamer is one of the main routes into the city of Luxembourg and is obviously very busy during the rush hour. With the arrival of the new European School, right next door to an existing technical high school, extra road and pedestrian traffic generated by the two schools was set to make traffic jams even worse.

### Improving traffic flow

To improve traffic flow on the N6, relieve pressure on a key roundabout and provide good private and public transport access to the schools themselves, new dedicated infrastructure leading from the main road to the schools was commissioned. Key features of this would be an underpass for the technical high school and a flyover with its distinctive inclined steel pylon and stay cable construction for the new European School.

### New flyover

The new flyover bridge – with two 66m spans – carries road traffic on a single unidirectional carriageway, as well as a mixed pedestrian and bicycle track on a curved radius of 102.25m.

The structure consists of two steel frames connected by struts and a reinforced concrete slab, founded on mass abutments and further supported by two huge concrete piers on the outer edge of the curve. The inside of the curve is supported by ten stay cables attached to an inclined free-standing steel pylon.

The steel structure was prefabricated off site and delivered to the workface in sections for lifting by crane and assembly on temporary piers. Stay cables were installed after the concrete deck had been poured. ►

1 The new flyover bridge is supported on mass abutments and two concrete piers on the outer curve, plus 10 stay cables on the inner curve.

2 Installation of the five pairs of BBR HiAm CONA stay cables began at the upper anchorages, on the inclined free-standing pylon.

3 A special feature of the design is the stainless steel ducting for the stay cables, installed using a cable winch-and-pulley system.

4 Installation of the stay cables at the lower anchorages, on the outside of the bridge structure.



2

**Stay cable system**

Our role was to prepare the stainless steel stay cable ducting tubes on the ground and to supply, install and tension the BBR HiAm CONA stay cable system.

A special feature of this structure is that it was designed with stainless steel ducting for the stay cables which we installed by using a cable winch and pulley system. The stays consist of bundles of 15.7mm diameter galvanized strand that has been tested and validated according to BBR procedures. There were five pairs of stay cables of between 7-15 parallel strands each which were individually waxed coated and sheathed, and further enclosed in stainless steel stay cable ducting.

We began installing the system from the top anchors and tensioning point on the pylon, to the lower anchors on the outside of the bridge structure.

In total, we used 3,900kg of stay cable strands and 325m of stainless steel ducting, plus 16 x 15 strand HiAm CONA anchors and four 7 strand HiAm CONA anchors.

The entire work was completed with great collaboration between the Tralux and ETIC teams – and without any access difficulties for guests attending the official opening of the nearby school during the construction period. ●



3



4

**TEAM & TECHNOLOGY**

**Owner** – State of Luxembourg, Ministry of Sustainable Development & Infrastructure, Regional Services Division

**Architect** – BENG

**Consulting engineer** – Schroeder & Associates

**Main contractor** – Tralux Construction

**Specialist contractors** – Victor Buyck Steel Construction (steel frame)

**Technology** – BBR HiAm CONA stay

**BBR Network Member** – ETIC S.A. (France)

## ANAEROBIC DIGESTER TANKS, HUNGARY

Band post-tensioning of circular tanks

## BUILDING FOR BIOGAS

BBR Network Member **KB Vorspann-Technik** has recently carried out post-tensioning of four digester tanks for biogas production in North Eastern Hungary. In the city of Miskolc, nearly 200km north-east of Budapest, two 16m high, 18m diameter post-tensioned digester tanks have been constructed.

The BBR VT CONA CMM tendons consisted of two compacted steel strands with a 165mm<sup>2</sup> cross-section and 1,820MPa stressing steel incorporated in bands. A further two 1,700m<sup>3</sup> digesters were built at a plant in Nyiregyhaza. Here, the tanks – both 18m high and 12m in diameter – were constructed with 142 BBR VT CONA CMM monostrand tendons made from 150mm<sup>2</sup> cross-section, 1,860MPa stressing steel. ●

1

- 1 Post-tensioning for the two 1,700m<sup>3</sup> digester tanks in Nyiregyhaza consisted of 142 BBR VT CONA CMM monostrand tendons.
- 2 The two 16m high, 18m diameter post-tensioned digester tanks in Miskolc, Hungary.

## TEAM &amp; TECHNOLOGY

## 1 Biogas Plant, Nyiregyhaza, Hungary

**Owner** – City of Nyiregyhaza  
**Main contractor** – Monolit – Epszer Kft.  
**Planner** – Nyirseg Konzorcium, Ke-Viz Zrt.  
**Technology** – BBR VT CONA CMM monostrand  
**BBR Network Member** – KB Vorspann-Technik GmbH (Austria)

## 2 Biogas Plant, Miskolc, Hungary

**Owner** – City of Miskolc  
**Main contractor** – Colas Alterra zrt.  
**Designer** – Megalit Mernoki Iroda KFT  
**Technology** – BBR VT CONA CMM band  
**BBR Network Member** – KB Vorspann-Technik GmbH (Austria)



2

WATER RESERVOIRS, AUSTRALIA & NEW ZEALAND

PT precast concrete and design & construction of PT tanks

# IMPROVING WATER SUPPLY

Members of the BBR Network around the world provide services which are vital to the water industry's ability to supply fresh water for growing populations. The long term performance and structural stability of reservoirs can be greatly enhanced by taking a post-tensioned approach to their construction.



- 1 Wilmers Road Reservoir, New Zealand – a structure standing 6m high and measuring 31m in diameter.
- 2 Mount View Reservoir, Australia – the new five million liter capacity post-tensioned concrete reservoir is 28.88m in diameter and 10.6m high.

## TEAM & TECHNOLOGY

- 1 **Client** – Stronger Christchurch Infrastructure Rebuild Team  
**Main contractor** – Downer  
**Engineer** – Opus International Consultants  
**Technology** – BBR VT CONA CMI internal  
**BBR Network Member** – BBR Contech (New Zealand)
- 2 **Owner** – Hunter Water Corporation  
**Main contractor** – Leed Engineering & Construction Pty Ltd  
**Designer** – Structural Systems Limited (Australia)  
**Technology** – BBR VT CONA CMI internal  
**BBR Network Member** – Structural Systems Limited (Australia)

### 1 Wilmers Road Reservoir, New Zealand

The Christchurch suburb of Hornby is changing rapidly, largely owing to residential and industrial growth that is being encouraged as part of a long-term community plan. The local BBR Network Member, BBR Contech, has provided post-tensioning for a precast concrete water tank which will improve water supply to the suburb.

Recognizing that the community needed an additional water supply, Christchurch City Council has built a new water supply pump station in the area. The facility comprises a pumping station and a freshwater holding tank, with the latter having a capacity of more than 3.7 million liters. BBR Contech was called on to provide post-tensioning services for the precast concrete panels that form the tank wall –

a structure standing 6m high and measuring 31m in diameter. The work involved:

- supplying the panel manufacturer with ducting for the tendons, which was cast into the panels
- once the panels were assembled on site, coupling the ducting and carefully installing the 11 tendons – comprising seven 12.7mm strands each – horizontally in the panels, effectively encircling the tank's circumference
- stressing the tendons to the desired load, then grouting them in place.

The project is now complete, providing the residents and businesses in the area with a much-improved water supply and a structure that, thanks to the use of post-tensioning technology, can withstand the damaging forces of an earthquake.





2

## 2 Cessnock & Lochinvar Hunter Region, Australia

The post-tensioning for two concrete water tanks has recently been designed and installed by Australian BBR Network Member, Structural Systems. Increased demand led Hunter Water Corporation to embark upon a water supply upgrade for parts of the Hunter Region. Two of the projects within this program were the Cessnock Water Supply Upgrade and the Maitland North Rothbury Water Supply Upgrade – each of which required the design and construction of a new reservoir. At the Mount View Reservoir, part of the Cessnock Water Supply Upgrade, a five million liter concrete reservoir was constructed. The new reservoir is 28.88m in diameter and 10.6m in height. Meanwhile, for the Maitland North Rothbury Water Supply Upgrade project, at Lochinvar, a 10ML tank with a 46.28m diameter base and 10m high walls 10m was constructed. Structural Systems provided the detail design for the reservoirs, including post-tensioning services. The design incorporated the use of a post-tensioned slab on ground, vertical precast panels for the walls with post-tensioning both vertically and circumferentially. The slabs on ground consisted of a 150mm thick concrete slab connected to a 600mm deep x 2000mm wide ring beam. Precast panels were cast on site and lifted into position. The panels were 280mm thick varying in width from 3300mm to 4100mm – and weighing up to 28t. Individual panels were joined with circumferential post-tensioning tendons stitched together by a cast in-situ concrete infill joint. Due to program constraints the reservoirs were constructed concurrently and successfully completed on time and within budget. ●

## ETHANE TANK, PORSGRUNN, NORWAY

Horizontal & vertical tank post-tensioning

# GEARING UP FOR GAS

As part of an expansion plan for the INEOS site at Rafnes in Norway – explains John Taraldsen of BBR Network Member, KB Spenneteknikk – the company was hired to provide post-tensioning services for a new ethane tank.

The new tank – along with expanded infrastructure – is being constructed in an industrial park in Porsgrunn, Norway – approximately 200km from Oslo. The new facility for INEOS will expand the company's ability to access ethane from world markets and secure long term competitiveness and jobs at the site. The main contractor, our client, slipformed the concrete walls of the tank and we were on site during the operation. For the horizontal tendons, we used 204 BBR VT CONA CMI 1206 tendons with 170t of 15.7mm diameter strand (150mm<sup>2</sup>, 1,860MPa). The vertical post-tensioning is made up of 52 CONA CMI 0406 loop tendons and we used 17t of strand. Standing 32m high with an external diameter of 45.7m, the new tank will be capable of holding 30,000m<sup>3</sup> of ethane and will be ready to receive its first consignment in the second quarter of 2015. ●

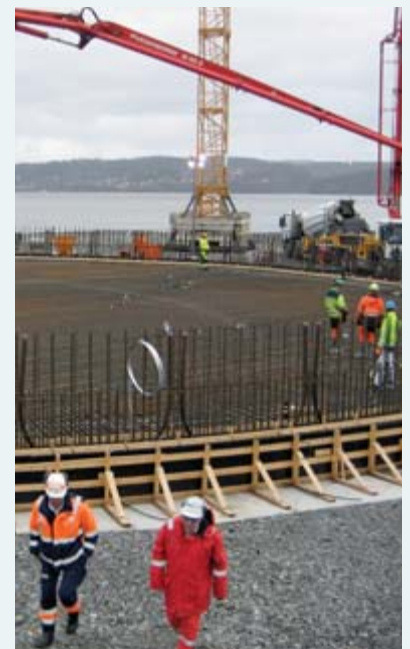

## TEAM & TECHNOLOGY

**Owner** – INEOS / Noretyl  
**Client** – Veidekke Entreprenør AS  
**Designer** – TGE Gas Engineering GmbH  
**Technology** – BBR VT CONA CMI internal  
**BBR Network Member** – Spenneteknikk AS (Norway)



## BRIDGE SLIDING, WESTERN AUSTRALIA

Development & execution of specialist bridge slide operation

# SLIDING WITH SAFETY & SPEED

A bridge sliding operation carried out in connection with a regional railway link project admirably demonstrates the care, skill and precision with which the BBR Network delivers customer requirements. Mark Sinclair, General Manager (Civil Engineering), of Structural Systems – the BBR Network Member in Australia – recounts how a lateral bridge slide design and sliding operation was jointly developed with the main contractor for Package C of the Melbourne Regional Rail Link Project.

“The lateral slide method was chosen to minimize the impact on rail traffic as part of the grade separation works, thus allowing Anderson Road traffic to pass under the rail line.”



2



3

- 1 Regional rail link, Melbourne – sliding of the twin track rail bridge to the rail alignment during a possession of the tracks.
- 2 SSL Australia’s site team executed the bridge slide during three consecutive 12 hour shifts. Pictured here is the night crew (left to right): Jeff Babbage, Kennedy David, Alan Denning, Kane Goodrope and Daniel Reardon – Mark Sinclair was behind the camera.
- 3 Two of the three jacks can be seen in this photo. The isoflow pump and control system ensured equal hydraulic flow to all jacks regardless of any load difference, which ensured constant movement in all locations and no unexpected loads or movements on the bridge during sliding.

The project involved the lateral sliding of a two span, twin track skewed composite rail bridge from its assembly area, to the rail alignment during a shutdown. The lateral slide method was chosen to minimize the impact on rail traffic as part of the grade separation works, thus allowing Anderson Road traffic to pass under the rail line. The 45m long, 11m wide, 1,350t bridge was launched laterally using three of our 145t by 1.4m stroke lifting system jacks and a modular 56mm coupled segmental high tensile bar system. This system provides a factor of safety in excess of 2.5. The hydraulic jacks were controlled by an Isoflow pump and console, which enables equal hydraulic flow and therefore equal jack extension regardless of the individual load in each of the bars.

A pull back system was designed, detailed and supplied should the need arise to reverse the bridge, but this was not needed in this instance, but is a necessary insurance considering that launch timing is always critical. The site works were carried out over three consecutive 12 hour shifts starting on the morning of 7th October 2013. The day crew set up and tested the system, then the night shift came in to launch the bridge 25m into the final position and achieved an accuracy, both longitudinally and laterally, of 2mm. The actual launching works took seven hours, then the day crew returned and completed decommissioning and packing up the system. ●

## TEAM & TECHNOLOGY

**Owner** – VicTrack Access (V Line, Metro and ARTC)

**Main contractor** – Thiess Balfour Beatty Joint Venture

**Designer** – Parsons Brinckerhoff & SKM (lead designers), Structural Systems (specialist launching system)

**Technology** – Sliding

**BBR Network Member** – Structural Systems Limited (Australia)



1



ZURICH MAIN RAILWAY STATION, SWITZERLAND

Tunneling under southern wing

# INNOVATIVE TUNNEL CONSTRUCTION

With the Cross City Link project, a new railway line is currently under construction in Zurich to connect the western part of the city with the main station and Oerlikon station to the north. A significant part of the project is the 4.8 km long Weinberg Tunnel – which runs into a newly built station directly underneath the historical main station. Fabian Persch of local BBR Network Member, Stahlton AG, describes his company’s innovative approach to meeting the post-tensioning challenges of this major project.

For a length of 110m, the new Weinberg Tunnel runs below the 150-year old heritage-protected southern wing of the station – thus, the tunnel had to be constructed without causing any structural damage to the building. Construction in close proximity to the southern wing, as well as the logistical difficulties involved with tunneling beneath an intensively used railway hub, has required innovative solutions.

**Construction method**

The construction method chosen for the undercrossing was a variation of the top-down solution. Top-down construction consists of a basement roof slab supported

on diaphragm walls that provide lateral support as the basement is excavated. Due to the lack of access above ground, the slab and the diaphragm walls had to be constructed using a conventionally driven system of longitudinal and transverse tunnels.

A total of 29 support beams, which were cast inside the transverse tunnels, form a slab supported by the diaphragm walls. Protected by this structure the actual tunnel works could be carried out. Once completed the longitudinal tunnels will function as access passages, from which the post-tensioning of the support beams can be checked and replaced if necessary.

- 1 Trolley with stressing jack.
- 2 Reinforcement and formwork of the end beam.
- 3 Installation of monostrands with deviation device.

**TEAM & TECHNOLOGY**

**Client** – Swiss Federal Railways (SBB)  
**Main contractor** – ARGE Tunnel Weinberg Oerlikon  
**Designer** – Pöyry Schweiz AG  
**Technology** – CONA electrically isolated  
**BBR Network Member** – Stahlton AG (Switzerland)



2

### Construction sequence

The size of the two 110m long longitudinal tunnels was designed to enable the construction of the diaphragm walls and the driving of the transverse tunnels. The size of the transverse tunnels was given by the driving requirements and the static analysis for the support beams that had to be installed. The driving of the transverse tunnels and the concreting of the beams was carried out using a step-back procedure – that is, starting with the primary tunnels and followed by secondary tunnels between them. On average, every eight working days a support beam could be filled with up to 380m<sup>3</sup> of self-compacting concrete. Subsequently, the end girders which transfer the loads to the diaphragm walls were concreted. The end girders also contained the anchorages of the post-tensioning tendons.

### PT challenges

For the design of the slab post-tensioning, a multitude of boundary conditions had to be considered. Swiss Federal Railways' guidelines require all tendons to be electrically insulated. Also, potential replacement of tendons at a later stage had to be ensured. The main challenge, however, was the extremely limited working space in the tunnels. After concreting of the end beam, the clear distance to the tunnel walls was very narrow with a maximum width of 1.50m. A strand overlength that is normally required for tensioning tendons or destressing them for later replacement, was not available. Neither could conventional lifting equipment for the stressing jack be used in the narrow tunnel.

### Unique PT system design

The post-tensioning system that was eventually designed can certainly be considered unique. The tendons consisted of sheathed monostrands, which were pushed into cast in-situ plastic pipes in the transverse beams. To make sure that they withstand the concrete pressure, the pipes were filled with water during concreting. The strand coils had to be placed outside the tunnel – and the monostrands had to be pushed through using a long guide tube and special deviation device. In total, 3,600m of post-tensioning tendons – amounting to 80t of prestressing steel – were installed in the supporting load transfer slab. Tendon stressing was carried out with a bell-shaped grip, which was screwed onto the threaded anchor-heads and pulled by a specially manufactured stressing jack. Shims were placed between the stressed anchor heads and the bearing plates to maintain the elongation. Destressing of the cables at a later stage is achieved by simply removing the shims. Thus a strand overlength was not needed for stressing or for replacement.

For placing the jack which weighed around 1,000kg, we designed and manufactured a suitable lifting trolley that could be moved along the end girder. After tendon stressing, the anchorages were sealed and the tendons were electrically insulated from the structure. After completion of the post-tensioning, the bracing loads from the slab were transferred actively to both diaphragm walls – then the tunnel excavation works under the completed transfer slab could begin. ●



3



1

CONTAINER TERMINAL, PORT OF RIJEKA, CROATIA

Post-tensioned beams

# CONTAINING STRENGTH FOR ADRIATIC

Since it first opened some 25 years ago, container traffic through Rijeka's Brajdica Container Terminal has constantly increased. Despite the economic recession, this trend has continued and increasing its capacity was vital to ensure future success of the facility. Kresimir Bogadi of Croatia-based BBR Adria takes up the story.



2

The Brajdica Container Terminal sits on Croatia's Northern Adriatic Sea coastline, on the southern side of the Rječina river delta, south of the city of Rijeka. The project to increase capacity at Brajdica is part of the wider Rijeka Gateway Program to improve life and facilities for citizens, as well as to attract private investment into the area – and maximize the use of the port in a competitive market place.

The Terminal's busiest year, in 2008, saw more than 170,000 TEU (20 foot equivalent units) containers being transshipped. The capacity of the existing container terminal is estimated to be 250,000 TEUs per year, mainly due to the limited container storage space.

1 The new quay for the Adriatic Gate Container Terminal near Rijeka takes shape at the busy container port.

2 Work in progress to connect the coastal ring beam and anchor wall behind using BBR VT CONA CMI / CME tendons.

### Phase II outline

Construction of Phase II of the Terminal includes a 328m extension of the coast and construction of a 50,000m<sup>2</sup> storage area – effectively doubling container storage capacity. There will also be a new checkpoint on the D404 road to enable rapid truck transit and unify all services arriving or departing. Improved rail loading facilities for a larger number of containers is also part of the planned upgrading program.

As a part of the second phase of construction of the Brajdica Container Terminal, 14.5m deep berths have been built to enable safe mooring of larger container ships. BBR Adria is installing 25 BBR VT CONA CMI / CME tendons in the quay wall – to connect the coastal ring beam and anchor wall behind. The tendons are formed in two parts.

### Two part PT tendons

The first part is in the coastal ring beams and is 3m long, consisting of a CONA CMI 1206 passive anchorage and CONA CMI 1206 coupling anchorage. This part of the tendon was grouted with cement grout after stressing.

The second part of the tendon is a replaceable BBR VT CONA CME tendon connected to the first part with a CONA CMI 1206 coupler. Construction of these removable tendons was performed such that the tensioning element has multiple corrosion protection on its whole length. The CONA CME tendons are each made up of 12 galvanized strands individually greased and sheathed and further protected in a 110mm diameter HDPE pipe. The new quay, at the now renamed Adriatic Gate Container Terminal (AGCT), was officially opened by Sinisa Hajdas Doncic, the Croatian Minister of Maritime Affairs, Transport and Infrastructure, during 2013. AGCT is now poised to support the Port of Rijeka in becoming one of the most competitive container ports on the Adriatic. ●

## TEAM & TECHNOLOGY

**Client** – Port of Rijeka

**Main contractor** – GP Krk

**Designer** – Rijeka projekt

**Technology** – BBR VT CONA CMI internal, BBR VT CONA CME external

**BBR Network Member** – BBR Adria d.o.o. (Croatia)

## INDUSTRIAL HARBOR, HORSØY, NORWAY

Two stage installation of ground anchored crane base

# LIFTING POWER

In Kleppestø, near Bergen in western Norway, BBR Network Member Spenneteknikk has carried out a two-staged ground anchoring operation for foundations forming a harbor crane base. Stig Sjølbør describes his company's work.

Stage 1, the foundation works, started in spring 2010 with plans already in place to install a crane on the harbor in the future. Therefore, when constructing the harbor, the foundations were built with this in mind – a ground anchor with a K-coupler was installed to allow later connection of the crane to the foundation.

### Post-tensioning works

We used 16 x 150mm<sup>2</sup> BBR VT CONA CMG ground tendons with a length of between 28-33m. The post-tensioning strands were 15.7mm in diameter with an Ultimate Breaking Strength of 1860N/mm<sup>2</sup> – greased and plastic coated on the free length.

The main contractor performed the casting of the foundations and our client performed the drilling works. We installed and grouted the permanent anchors and then we stressed the K-coupler anchors. Then, we mounted a protective grease-filled cover over the anchorage, for connection when the crane was ready to be installed.

### Making the connection

We returned to site, some months later, to carry out the second stage of the project. We installed a further 18 BBR VT CONA CMG ground tendons of lengths between 4.5-6.6m and connected the strands to the K-couplers already installed during Stage 1, then the concrete wall was poured.

The steel crane connection was fixed in place after the concrete had hardened and then we stressed and grouted the tendons. When the crane itself had been mounted, it was successfully tested with a load of 400t. ●

## TEAM & TECHNOLOGY

**Owner** – Horsøy Industrihavn AS

**Client** – Kynningsrud Fundamentering AS (Stage 1), Framo Engineering AS (Stage 2)

**Main contractor** – Veidekke AS

**Designer** – Norconsult AS

**Technology** – BBR VT CONA CMG ground  
**BBR Network Member** – KB Spenneteknikk AS (Norway)





1



2

EARTHQUAKE RESISTANT BUILDINGS, CANTERBURY, NEW ZEALAND

Application of PRESSS technology

# DIVERSITY IN PRESSS TECHNOLOGY

PRESSS (PRecast Seismic Structural System) technology is taking New Zealand by storm, especially in Canterbury, as part of the post-earthquake rebuild program says BBR Contech Southern Regional Manager, Peter Higgins.

Suited to steel, concrete and LVL (laminated veneer lumber) structures, PRESSS technology delivers protection against serious earthquakes while minimizing seismic damage and the associated costs of smaller tremors.

**1 Police station, Rotorua**

Police officers serving in the Rotorua area will soon be based in a brand new police station – and not a moment too soon according to those working in the existing premises.

The two-storey station is being constructed using PRESSS technology, with tensioning cables installed in the concrete shear walls, beams and columns to allow it to move in an earthquake without sustaining serious damage.

For this project, the BBR Contech team is installing 62 BBR VT CONA CME 12-strand, greased and sheathed tendons into the precast walls.

The new station is due to open in March 2014, offering an environment eminently suited to modern-day policing while reflecting the unique features of Rotorua, particularly the prominence of Maori art and culture.

**2 Trimble Navigation offices, Christchurch**

While Trimble Navigation's Christchurch office survived the 2010 and 2011 earthquakes, it was not destined to last for long – in 2011, the entire building was destroyed by fire.

Replacing it will be the first building in New Zealand constructed with post-tensioned LVL frames and post-tensioned LVL walls. Standing two storeys high, it will also include clever devices that reduce earthquake damage by dissipating the energy and controlling movement in the structure itself, as well as beam column joints with forced rocking points which control joint movement and damage. The energy dissipaters can be easily replaced after an earthquake, providing economical repair alternatives. BBR Contech's role is to post-tension the building's nine LVL shear walls and 19 horizontal LVL beams. That means:

- installing 54 x 50mm diameter PT bar tendons vertically through the walls and connecting them to screw piles that terminate in the gravel layer
- installing six multi-strand, 15.2mm diameter strand tendons in each beam. The tendons are greased and sheathed to protect against corrosion and the ends are wrapped in corrosion protection tape and capped to provide an additional barrier against the elements.

In another innovation, the building's strength will be constantly monitored – and tendons easily removed and replaced if necessary. The project, and its impressive commitment to earthquake resistance, is already earning accolades – it won a 'highly commended' award in the 2012 Timber Design Awards. ●

**TEAM & TECHNOLOGY**

- 1 Client** – New Zealand Police  
**Main contractor** – Canam Construction  
**Engineer** – Spiire  
**Technology** – BBR VT CONA CME external  
**BBR Network Member** – BBR Contech (New Zealand)
- 2 Client** – Birmingham Drive Properties Ltd  
**Main contractor** – City Care Limited  
**Engineer** – Opus International Consultants  
**Technology** – BBR VT CONA CME external, PT bar  
**BBR Network Member** – BBR Contech (New Zealand)



## DENISON ROAD GRADE SEPARATION, TORONTO, CANADA

Ground anchoring

# ANCHORING IN TORONTO



1



2



3



4



5



6

Work is underway in the Denison Road area of Toronto on a major grade separation project to improve railway services and accommodate a new airport rail link. Tim Pahapill of BBR Canada explains, through the photographs below, how their work involves the installation of up to four layers of ground anchors along a sheet-piled retaining wall which forms a cutting below the railway line. As can be seen, the ground conditions are extremely challenging.

**1** A tieback drilling machine bored holes, under artesian conditions, for the up to 38m long ground anchors which would later be grouted and tensioned against the sheet piled wall.

**2** For ease of fabrication, transportation and to save time on site, tendons were delivered in cut-to-length coils and an uncoiling turntable was used to unwind them during installation.

**3** Once installed and the bored hole fully grouted, the strands were individually secured in the anchor heads by placing wedges into the anchor head wedge holes.

**4** After installation, the ground anchors were filled with a special grout mixture as a corrosion inhibitor and to create the bonded length, while the free stressing lengths remained greased and sheathed for protection.

**5** After installing the anchors and a minimum grout strength of 28MPa had been achieved, the tendons were stressed, proof tested and locked-in. A typical stressing activity is shown here with the team stressing the ground anchors against the external bracket mounted on the sheet piled retaining wall beneath the new railway bridge.

**6** The first two rows of ground anchors are fully installed and stressed to their prescribed lock-in loads. The first row is finally capped and the second row is being prepared for capping. ●

## TEAM & TECHNOLOGY

**Owner** – Metrolinx

**Main contractor** – Dufferin Construction Company

**Shoring & drilling contractor** – Deep Foundations Contractors Inc.

**Technology** – BBR CONA ground

**BBR Network Member** – Canadian bbr Inc. (Canada)

## EASTERN INTERCEPTOR SEWER, AUCKLAND, NEW ZEALAND

Specialist refurbishment & treatment of damaged sewer

# GOING UNDERGROUND

The term 'Eastern Interceptor' may sound like a fighter jet left over from the days of the Cold War, but for the BBR Contech team the expression has a distinctly different meaning explains their Project Manager, Oliver Smith.

Completed in 1962, the Eastern Interceptor is a large-diameter, reinforced-concrete wastewater pipe that follows a 19km path from Auckland's Okahu Bay to the Mangere Wastewater Treatment Plant. It is a vital part of the city's wastewater management system, carrying about two-thirds of its wastewater and acting as the main collection point for many large and small sewers. For this reason,

Watercare – the company providing water and wastewater services to the Auckland region – maintains a rigorous monitoring, maintenance and, where necessary, repair program. BBR Contech was most recently involved in 2005, when we repaired several sections in what was thought to be the first large-scale remedial concrete works to be carried out in a fully live, man-entry sewer in New Zealand.





2



3

“This has required us to take a scrupulous approach to planning and implementing the project, and to keeping the affected community well-informed along the way.”

- 1 Auckland’s Eastern Interceptor Sewer is a 19km long reinforced concrete pipe which required vital man-entry maintenance works.
- 2 Wearing of dry suits equipped with fresh air supplies and adhering to strict underground time limits form part of the health and safety regime on BBR Contech’s sewer maintenance projects.
- 3 Preparation of the sewer pipe surface is carried out using high pressure blasting, then a specialist spray is applied to the walls to protect against biogenic sulphide corrosion.

## TEAM & TECHNOLOGY

**Client** – Watercare Services  
**Engineer** – AECOM  
**Technology** – MRR range  
**BBR Network Member** – BBR Contech (New Zealand)

### Latest contract

We have recently been called upon again, this time to remove and replace damaged concrete in two other parts of this critical element of Auckland’s infrastructure – one a 205m-long section at the wastewater plant itself, and the other a 440m-long section in Mount Wellington. The latter is posing some particularly complex challenges for the team, as it is located in a heavily populated residential area which includes a primary school. This has required us to take a scrupulous approach to planning and implementing the project, and to keeping the affected community well-informed along the way.

### Meticulous detail

Work like this is never pleasant for the BBR Contech team, with a hazardous working environment in which everyone is required to follow stringent health and safety policies. These include wearing dry suits equipped with adequate supplies of fresh air – and maintaining a strict limit on the time spent in the underground pipe environment. In Mount Wellington, the team also has to have a constant focus on minimizing noise and other disruptions to the residents nearby.

Spread over two stages and due for completion in early 2015, the project involves:

- preparing the surface using robotic high-pressure water blasting, which is very effective in removing the affected concrete without disturbing raw sewage
- applying 350t of specialized coating – a technologically sophisticated calcium aluminate product that is sprayed on to provide highly effective, high-strength, corrosion-resistant protection against biogenic sulphide corrosion.

While those working on the project will no doubt be relieved to see it completed, they can be very proud of their role in helping to ensure that Auckland’s wastewater system continues to perform well into the future. For our part, the project has reflected the very best of expertise, experience and collaboration – qualities that we at BBR Contech promote and value highly. ●



1



2

BULACAN LINE 2 CEMENT SILO 9, NORZAGARAY, BULACAN PROVINCE, PHILIPPINES

Design, retrofitting & post-tensioned construction

# STRENGTHENING FOR EUROCODE COMPLIANCE

“A retrofitting system was needed that would not require a shutdown of the silo while the works were being executed.”

BBR Network Member, BBR Philippines Corporation has provided post-tensioning services at a plant belonging to one of the world’s largest cement producers – the Swiss-based Holcim Group. Rey Singh outlines the story behind the project.

The existing cement plant in Norzagaray, Bulacan Province was acquired by Holcim in 2004 to increase their local production capacity. As they require their structures to be compliant with both local and European construction codes, they tasked a European engineering consultancy firm to undertake the necessary design reviews. Their study for Cement Silo 9, which was built in 1995, showed that it needed to be structurally upgraded to conform with the local codes, ACI provisions and European code requirements for silos considering the dynamic forces acting during extraction in concrete silos with inverted cones. They recommended that Cement Silo 9 be limited to a 40% storage capacity until it had been strengthened to conform to Eurocode standards.

**Technical aspects**

Time was now of the essence and pressure was on to increase much-needed storage capacity without disrupting the plant’s commercial operations. A retrofitting system was needed that would not require a shutdown of the silo while the works were being executed.

Silo 9 is a 41m high, 10,000MT cement storage silo with an inside diameter of 20m and wall thickness of 650mm. It also has an annex wall with a 10.524m curvature length jutting out on one side as this was intended for the future construction of Cement Silo 10 – Cement Silo 9’s twin silo.

- 1 External post-tensioning is being applied to the external wall of the cement silo for strengthening in line with Eurocode requirements.
- 2 Work at the cement plant was able to continue while work was in progress – a benefit of adopting an external post-tensioning solution.

**TEAM & TECHNOLOGY**

**Owner** – Holcim Philippines, Inc.  
**Main contractor** – BBR Philippines Corporation  
**Technology** – BBR CONA external  
**BBR Network Member** – BBR Philippines Corporation (Philippines)

## MOUNT VICTORIA TUNNEL, WELLINGTON, NEW ZEALAND

Strengthening with ground anchors

# ORCHESTRATING TUNNEL ACTIVITIES

The journey between the City of Wellington and its airport, takes motorists through the Mt Victoria tunnel – where many take part in the symphony of tooting horns that's long been customary practice as the vehicles pass through. With more than 620m to cover, there's plenty of time to raise a tune! Recently, motorists have acquired a new audience – the team from BBR Contech which has been carrying out strengthening work on concrete walls at the tunnel's entrance and exit portals.

Opened in 1931, the tunnel was the first road tunnel in New Zealand to be mechanically ventilated. The technology remains an important feature today, as the tunnel is now a thoroughfare for about 45,000 vehicles a day, as well as hundreds of pedestrians and cyclists. The tunnel is a vital piece of infrastructure on State Highway 1 and keeping it in top condition is of prime importance.

Therefore, New Zealand Transport Agency have awarded BBR Contech the contract for strengthening the tunnel's concrete walls at the entry and exit portals.

The project will anchor the walls in place to reduce the risk of damage or collapse in an earthquake. Given the weak ground conditions at the site, this is a complex task involving building a concrete beam to link the anchors through the walls, adding steel as extra reinforcement, installing the anchors and cementing them in place with high-pressure grouting to ensure a firm, long-lasting bond.

The work has been arranged to have minimal impact on those using the tunnel and, thanks to some careful screening, the construction workers are no distraction for drivers. Noise and traffic management plans are also helping to reduce the effects for those in the neighboring community, while a communication strategy ensures that those directly affected are kept up-to-date on progress. ●



1



2

- 1 The tunnel walls are being strengthened at the entry and exit portals.
- 2 The BBR team is screened from the road beneath while they grout the new anchors installed for the tunnel strengthening program.

## TEAM & TECHNOLOGY

**Client** – New Zealand Transport Agency  
**Engineer** – Opus International Consultants  
**Technology** – BBR CONA ground  
**BBR Network Member** – BBR Contech (New Zealand)



### External post-tensioning works

We proposed to upgrade the structural capacity of the existing Cement Silo 9 through external post-tensioning tendons. The use of external post-tensioning tendons has the flexibility to avoid obstructions, like the existing structures and services attached to Silo 9, and allows the contractor to work on the outside surface of the silo wall without interfering with the cement plant's operations.

The post-tensioning tendons are BBR CONA external tendons, each with four 0.5" unbonded strands. The grease and polyethylene sheathing of the unbonded strands serve as corrosion barriers as they are exposed to the elements in the sectors between the three reinforced concrete buttresses built to house the tendon anchorages. A total of 89 BBR CONA external tendons were looped around the cement silo.

Besides overcoming obstructions, limited working spaces and access problems due to the height of the silo, another major obstacle was the removal and demolition of the annex wall as this obstructed the installation of the post-tensioning tendons in its sector. Diamond saw cutting machines, set up on heavy duty modular ring lock scaffolding, were used to cut the annex wall segment-by-segment. The segments were individually brought to ground level by a mobile, telescopic crane and hauled away from the construction site.

Cement Silo 9 has now been loaded to 100% filling capacity – and its owners can be confident that it meets all required construction codes. Mabuhay!\* ●

\* For our non-Filipino readers, this is a frequently used local greeting meaning 'live' – as in 'live your life' or 'live long'.



1



2

NORTH RJECINA MOTORWAY BRIDGE, CROATIA

Rehabilitation with external post-tensioning

# FIRST REHAB IN 30 YEARS

The old northern Rjecina bridge was built between 1980 and 1984 and opened to traffic in 1988 when the whole section of motorway around the city of Rijeka had been completed. Since it opened, no rehabilitation work had been carried out on the bridge.

The bridge is positioned around 100m above the river valley. The bridge main span is 98.4m with lateral 45m spans supported on sloping piers and an additional independent 17.5m span on the west side which was required for tricky geological conditions. The foundation axis span is 131.65m.

**Rehabilitation work**

Rehabilitation work consisted of asphalt and superstructure hydro-isolation replacement, abutment rehabilitation, abutment expansion joint replacement and rehabilitation of other installations.

**PT tendon replacement**

As a part of the abutment rehabilitation, the external tendons which take over lifting force were replaced. In accordance with the design specifications, 32 x 7mm diameter BBRV Wire post-tensioning tendons were used. The upper part of the tendons were anchored with movable anchor heads, while the lower parts were anchored with passive non-movable anchor heads. Each strand was fixed into the anchor head using the cold-formed button heading process which ensures maximum efficiency. There were four 4.5m long tendons on each abutment. After replacing the wires and anchor heads, each tendon was stressed to a force of 200kN. Corrosion protection of the tendons was completed using new grease-filled HDPE pipes and protection caps. ●

- 1 External post-tensioning tendons were replaced as part of the bridge abutment rehabilitation project.
- 2 View of one of the carriageways as work had almost been completed – this was the first rehabilitation project carried out since the bridge opened in 1988.

**TEAM & TECHNOLOGY**

**Client** – HAC, Zagreb  
**Main contractor** – Viadukt d.d., Zagreb  
**Designer** – Institut IGH d.d., Zagreb  
**Technology** – BBRV wire  
**BBR Network Member** – BBR Adria d.o.o. (Croatia)



## TECHNOLOGY

### 64 RESEARCH & DEVELOPMENT

improving all round performance  
– stay cable dampers to counter  
vibration, plus cost-effective  
grouting accessories

### 68 TECHNICAL UPDATE

securing of AASHTO approval  
and current status of the  
BBR VT CONA CMX range

### 70 TECHNIQUES

Fabian Persch of Stahlton, the  
BBR Network Member for  
Switzerland, reveals the benefits  
of and method for prefabricating  
PT tendons

### 72 INSIGHT

technology and expertise from  
the BBR Network can breathe  
new life into weakened or  
damaged infrastructure and  
buildings – some of the techniques  
are showcased here

## RESEARCH &amp; DEVELOPMENT

Superior countermeasure for stay cable vibration

# SOLUTIONS FOR COUNTERING CABLE VIBRATIONS

Cable-stayed bridges have been built in greatly increasing numbers since 1950. Despite their wide use, there are still several areas of great concern, especially the effects and elimination of cable vibration phenomena. Within the BBR technology range, we offer a superior supplemental passive damping device – the BBR Square Damper – to combat cable vibrations.

Even newly constructed cable-stayed bridges have experienced quite severe vibrations – such as, for example, the Fred Hartman Bridge in Houston, Texas which has a main span of 381m and 192 stay cables. Excessive cable vibrations have also been observed on numerous other bridge structures.

Several cable vibration mechanisms have been identified – such as vortex shedding, cable galloping, parametric excitation (deck / pylon and cable interaction) and wind-rain induced vibrations – which create concern generally.





**Cable galloping**

Galloping was firstly detected in power lines which – under certain weather conditions – were observed to be vibrating and exhibiting high amplitudes at relatively low frequencies. Curiously, this phenomenon has never been reported in countries with a warm climate, but it is very common during the winter months in northern states of USA and Canada. Oscillations are transversal to the wind direction, occurring at frequencies close to some natural frequency and generally – for all wind speeds – above a critical value. In general, to ensure stability of the stay cable under galloping-like mechanisms, the following expression must remain negative:

$$\delta_{Req} > -\frac{\rho D}{4m f_k} U \left( C_D + \frac{\partial C_L}{\partial \beta} \right)$$

In which m, f<sub>k</sub> and D are, respectively, the linear mass, natural frequency and outer diameter of the cable. On the other side, U corresponds to wind speed and the term in brackets to the Den Hartog Coefficient. A detailed analysis of the above expression will show that stay cables will only be subjected to galloping when the Den Hartog Coefficient becomes negative, which may happen under the following conditions:

- outer shape of the stay pipe is not circular
- accumulation of ice on the stay pipe which noticeably modifies outer shape to non-circular
- wind flows on a plane non-orthogonal to the stay cable's axis.

**Wind-rain induced vibrations**

The phenomenon of rain-wind induced vibration is brought about by the simultaneous action of a low / moderate wind speed, together with the action of rain. Nowadays, it is considered that rain-wind induced oscillations cause about 95% of the reported vibration problems in cable-stayed bridges. In spite of this, it was not until the construction of the Meiko-Nishi Bridge in the 1980s that this phenomenon in cable-stayed bridges was reported for the first time. During construction, it was observed that the cables of the bridge – initially stable with respect to the action of the wind – started to become unstable in rainy conditions. Oscillations observed

were of the order of 0.55m when subjected to the effects of a 14 m/s wind. Today, it is also known that the action of the rain leads to the formation of two water rivulets, one on the upper cable side (unstable rivulet) and another on the down cable side (stable rivulet). Although the presence of the rivulets slightly changes the outer cable shape, some experiments performed by Yamaguchi in the 1990s showed that the vibration was very unlikely to be caused by a 'galloping-like' mechanism – but rather the oscillatory movement of the top rivulet, caused by the combination of gravity and aerodynamic forces. Past experience and intensive experiments in the field demonstrated that rain-wind instability occurs under the following conditions:

- wind flows in the same direction as the cables decline from the pylon to the deck
  - combination of light rain with relatively moderate wind speeds of around 8-15 m/s
  - outer surface of the stay pipe is smooth and not equipped with any countermeasure, such as helical rib or dimples.
- Analysis from earlier stay cable bridges shows that rain-wind induced vibration may be overcome if the Scruton number is high enough:
- S<sub>c</sub> > 10, if stay pipe has a smooth outer surface
  - S<sub>c</sub> > 5, if stay pipe is equipped with a helical rib or similar countermeasure. ➤

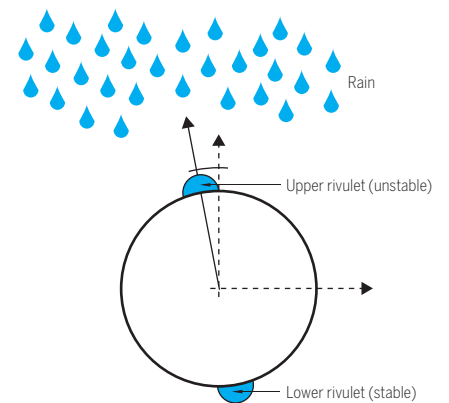

Illustration showing a cross section of an HDPE stay pipe

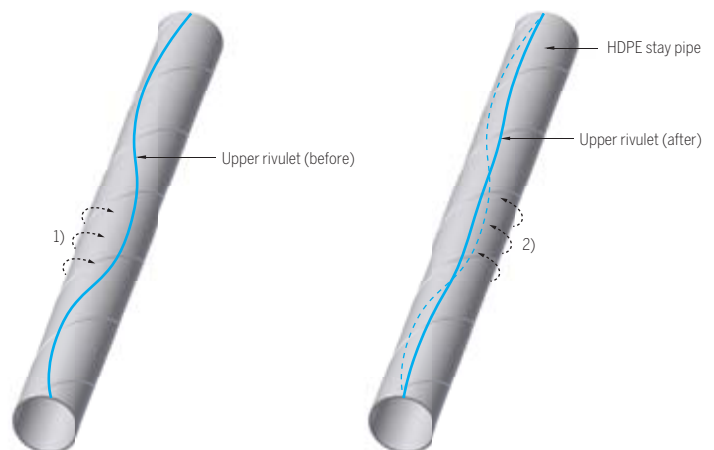

Illustration showing the movement of rivulet due to gravity (1)

Illustration showing the movement of rivulet due to wind flow (2)

### Dampers for Rio Corgo

Completed in 2013 by BBR Network Member BBR PTE, Portugal's Rio Corgo Viaduct features 88 HiAM CONA stay cables – ranging in size from 42 to 69 strands, with the longest cable measuring 159m. Following extensive cable vibration analysis, performed by the BBR HQ Technology and R&D team based in Switzerland, it was determined that 16 of the 88 stay cables would require additional supplemental damping to eliminate cable vibrations.

The BBR Square Damper is a superior supplemental passive damping device which is based on friction. The device can be used as an internal damper, where it is installed inside the steel guide pipe or alternatively as an external damper, attached to the cable free length using a damper housing and external brace. The main advantages of the BBR Square Damper are:

- the damper is not activated at low and non-critical cable vibration amplitudes, avoiding constant working of the damper and minimizing maintenance requirements
- the damping efficiency is independent of the acceleration and mode of cable vibration
- the damper has been proven, by testing, to achieve the Maximum Passive Supplemental Damping considered for a 'perfect damper' and thus the safety factors relating to Required Supplemental Damping can be reduced
- free longitudinal movement of the stay cable at the damper location is provided, allowing for temperature elongation and force variations of the stay cable without constraints
- the damping characteristics can be adjusted at any time by changing the 'clamping' force
- high endurance and constant performance
- easy inspection and low maintenance.

Due to its simple design, high efficiency, easy adjustability and low maintenance requirements, the BBR Square Damper is superior compared to other damping products available on the international market. The device can be fine-tuned and adjusted during its entire service life to best suit a particular cable configuration and specific susceptibilities to particular vibrations. All components of the damper can be inspected individually and are replaceable if required – for example, if there has been external damage or vandalism. ●

- 1 For Portugal's Rio Corgo Bridge – completed by Spanish BBR Network Member, BBR PTE – the BBR HQ Technology and R&D team performed extensive cable vibration analysis and determined that 16 of the 88 stay cables would require damping.
- 2 The BBR Square Damper is a superior supplemental passive damping device which is based on friction and can be installed as an internal or external damper.

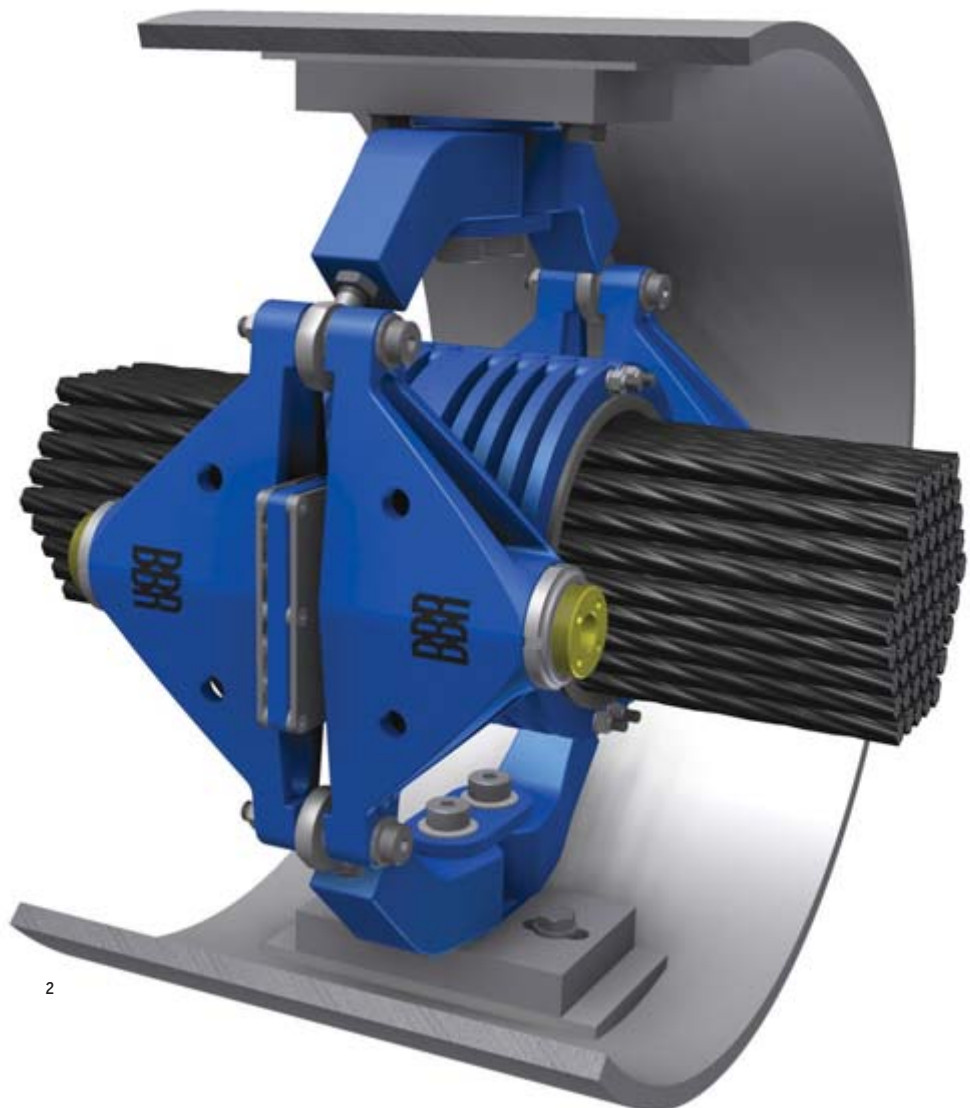

2

## RESEARCH &amp; DEVELOPMENT

New generation of grouting accessories

# GREEN AND COST-EFFECTIVE

Grouting plays a key role in the corrosion protection of post-tensioning tendons and the BBR Network has developed excellent techniques for completing this important task. Now, with our new range of grouting accessories this process has become even more cost-effective and environmentally friendly.

In the industry as a whole, there have been concerns associated with the grouting process for post-tensioning tendons and these are associated with potential impacts on both the construction program and environment. Therefore, we have developed a new range of grouting accessories specifically for the BBR VT CONA CMI and CONA CMM post-tensioning systems which improve efficiency and sustainability. Among the tools our team used during the development process of our new range was non-linear finite element analysis.

This has enabled us to ensure that material usage was fully optimized – so that we use just what is needed and no more. The range of accessories also includes a newer series of BBR grouting caps, made of organic polymer. They are able to withstand grouting pressures of up to 15 bars and are fully compatible with anchorages and couplers. The new caps showed significant cost reduction and an extraordinary reduction of the CO<sub>2</sub> emissions to the atmosphere. ●

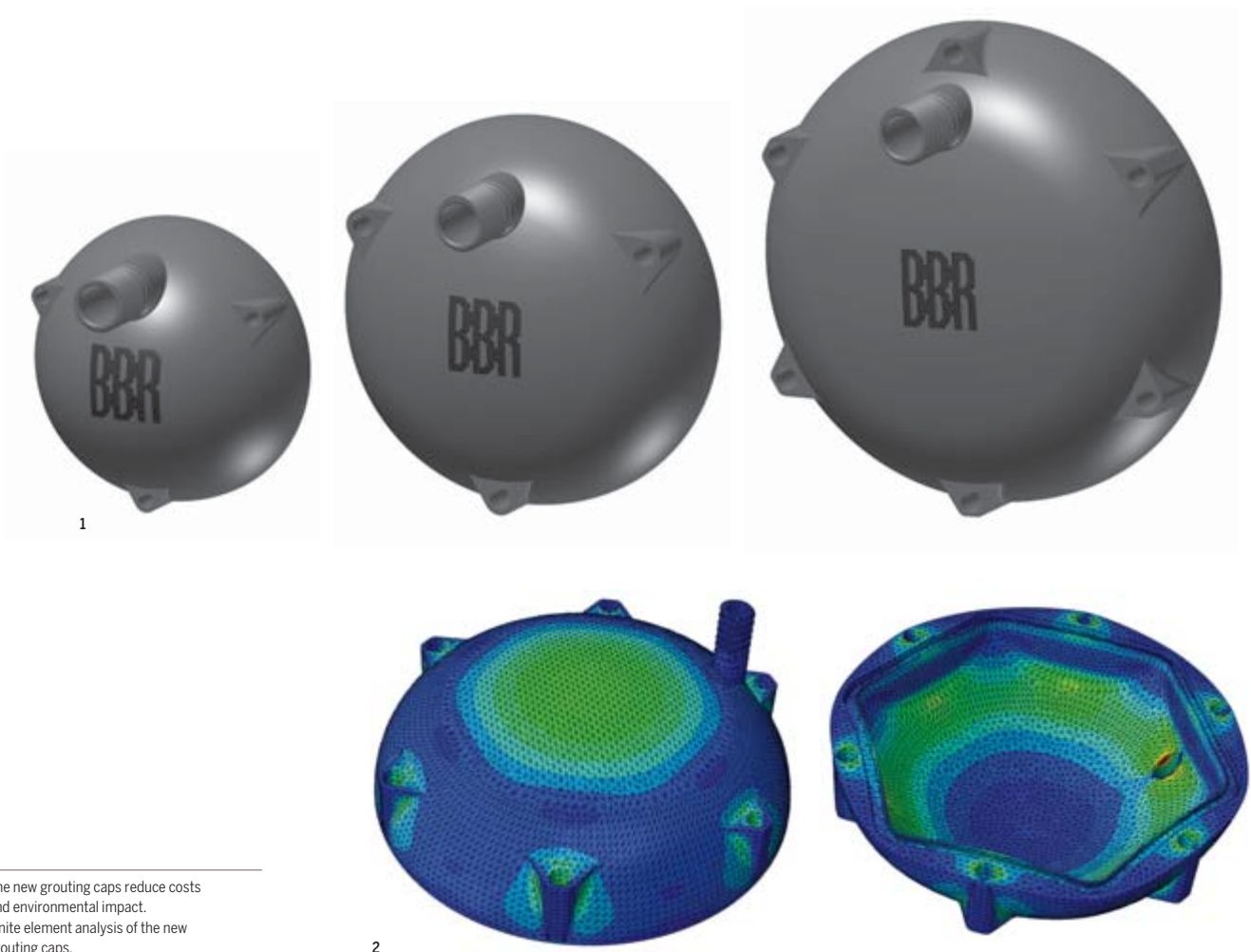

1 The new grouting caps reduce costs and environmental impact.

2 Finite element analysis of the new grouting caps.

## TECHNICAL UPDATE

New approvals &amp; renewals

# AASHTO APPROVAL FOR CONA CMI

While ETAG 013 has become state of the art in Europe and other regions worldwide, some regions – such as the Middle East – specify post-tensioning projects according to AASHTO.

BBR HQ has recently carried out additional initial type testing on the CONA CMI BT system according to AASHTO LRFD Bridge Construction Specifications, 2nd Edition, 2004.

### System testing

Among other items, the system testing included:

- static load tests including the deviation of the strands to represent the transition zone at the exits of the anchorage and at the coupler unit on PT tendons with up to 6106 strands
- load transfer tests for highly aggressive environments and concrete strength range from 19/23MPa to 35/43MPa on PT anchorages with up to 6106 strands.

The recent AASHTO approval tests confirmed the benefits of the CONA CMI BT system, with static load efficiency greater than 96% AUTS and reduced crack width at the local zone for its application in those special aggressive environments described in AASHTO LRFD Bridge Construction Specifications.

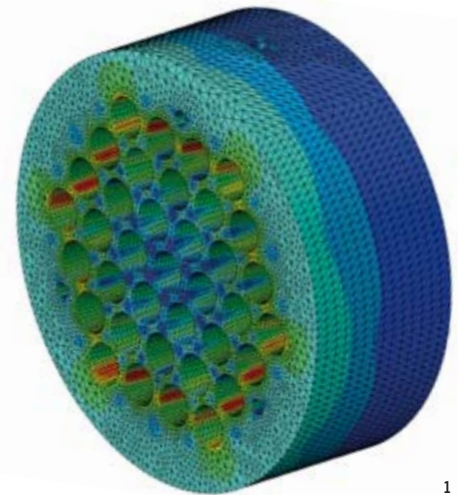

1

### Finite element modeling

While experimental testing gives global information about the performance of the CONA CMI BT anchorage system – for example, wedge slippage, deflection, etc – no internal information, such as stress / strain in the anchorage core at service and ultimate state, can be obtained. In addition, experimental tests are recognized as being time-consuming and expensive. However, by using the latest finite element modeling technology, our numerical analyses have complemented laboratory testing and confirmed geometrical, material and surface anchorage properties.

The finite element model takes into account all the mechanical behavior complexities which occur on CONA CMI anchorages when subjected to heavy prestressing loads, such as the wedge-tendon gripping interaction, the friction at the wedge-anchor head interfaces, as well as at the anchor head-anchor plate interface, local plasticity and large displacements at the wedge-anchor head interfaces.

Anchor head deflection and radial deformation data collected from the testing formed the basis for comparison with the numerical results. The agreement observed, between the experimental and numerical results, clearly showed the benefits of finite element modeling for assessing both the global and local behavior of the anchorage system.

The CONA CMI BT system has now been applied to the two 160m long flyovers at the Barka Interchange, part of the new Batinah Expressway project near Muscat, Oman. More information about the project is on page 32. ●



2

1 Finite element modeling (FEM) also proved to be beneficial for assessing both the global and local behavior of the CONA CMI BT anchorage system.

2 Laboratory testing of the CONA CMI BT system confirmed the benefits of the CONA CMI BT system for application in special aggressive environments as described in AASHTO LRFD Bridge Construction Specifications.



## TECHNICAL UPDATE

New approvals & renewals

# STATUS OF CONA CMX APPROVALS

Our BBR VT CONA CMX range of completely new post-tensioning technology was launched in 2006 and, since then, European Technical Approvals (ETAs) have been progressively sought, awarded and renewed for different systems within the CONA CMX range. This is a significant investment – in terms of both time and costs – however, it has ensured that the BBR Network has the latest CE-marked, high quality technology to offer its customers.

The CONA CMX range was developed in response to market needs and offers considerable budget, program and environmental benefits – such as less space needed in the anchorage zone, stressing at lower concrete strengths and reduced requirement for reinforcement in the anchorage zone. Securing and maintaining ETAs for our CONA CMX systems is important, as they are the everyday technologies used by BBR Network Members for delivering the highest quality services to their customers worldwide.

### BBR VT CONA CMM Single

The new BBR VT CONA CMM Single European Technical Approval ETA-12/0282 has been issued and is valid until June 2018. The key features and benefits of the new internal system with single strand are:

- Applicable for bonded applications with corrugated steel or plastic duct
- Applicable for unbonded tendons with grease / wax as filling material or with monostrands
- Exchangeable and restressable for unbonded tendons
- Full stressing at low minimum concrete strength (20/24MPa).

### BBR VT Plastic Duct

The European Technical Approval for the BBR VT CONA CMI internal bonded post-tensioning system with 04 to 31 Strands – ETA-06/0147, has been recently renewed up to March 2018. This approval now includes the BBR VT Plastic Duct which has the following key features:

- BBR VT Plastic Ducts are circular with inner diameters from 50mm to 130mm and they are made of polypropylene with toroidal corrugations
- BBR VT Plastic Ducts were tested in accordance to *fib* bulletin 7, for a working temperature range of –20°C to +50°C
- Enhanced corrosion protection against aggressive chloride environment
- Lower and more reliable friction coefficient, beneficial for longer tendons and circular tank construction
- Reduced risk of fretting fatigue of tendons

### Recent renewal of ETAs

The following European Technical Approvals have been renewed for the next five years:

- BBR VT CONA CMI SP – Internal bonded post-tensioning system with 01 to 61 strands – European Technical Approval ETA-09/0287, renewed up to June 2018
- BBR VT CONA CMI BT – Internal bonded post-tensioning system with 02 to 61 strands – European Technical Approval ETA-09/0286, renewed up to June 2018
- BBR VT CONA CME – External post-tensioning system with 04 to 31 strands – European Technical Approval ETA-07/0168, renewed up to December 2017.

### National CONA CMX approval updates

In Australia, CONA CMI BT has been approved for sizes up to 6106 by the Roads and Maritime Service (RMS) and has been used by local BBR Network Member, Structural Systems on the Hunter Expressway project (see page 21). CONA CMI has also been approved in Switzerland, with Stahlton as the local PT Specialist. This approval is based on the CONA CMI European Technical Approval ETA-06/0147 and includes the full range of BBR VT Plastic Ducts (both round and flat) and specifications relating to prefabricated tendons. Meanwhile, in Germany, the Deutsches Institut für Bautechnik (DIBt) has extended approval of our external band systems for general use for another term. ●

A complete series of the latest approvals – along with CAD drawings and technical brochures – is now available for download from our website – [www.bbrnetwork.com/downloads/approvals.html](http://www.bbrnetwork.com/downloads/approvals.html).

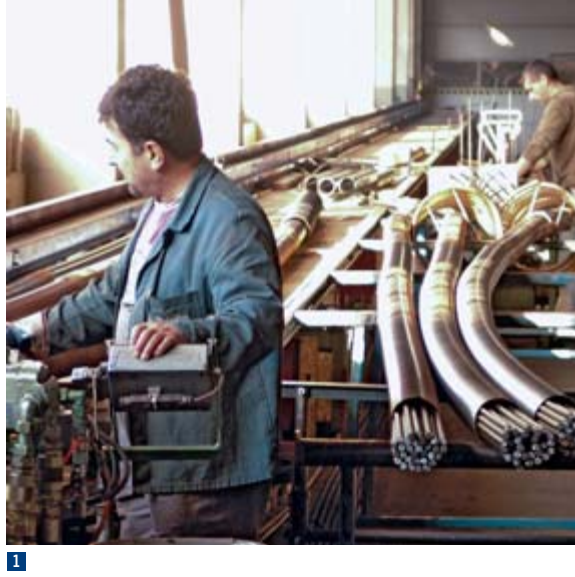

1



2

## TECHNIQUES

Prefabrication of post-tensioning tendons

# REELING WITH SUCCESS



While it is not a new idea, the off-site prefabrication of post-tensioning tendons can offer great benefits for certain construction projects. With its history of being a wire tendon supplier, the BBR Network Member for Switzerland, Stahlton AG developed the infrastructure and capability necessary to prefabricate tendons many years ago. Today, they still prefabricate the bulk of tendons for use on their projects. Fabian Persch, Product Manager PT, of Stahlton outlines the background, advantages and the process.

Our experience of prefabricating post-tensioning tendons stretches back to the early days of the shared BBR and Stahlton history. Unlike strand tendons, wire cables need to be cut to an exact length, which can be best carried out in a workshop. So it has become customary for us to fabricate our tendons off-site.

We have found that prefabrication offers a number of advantages for both the BBR PT Specialist and the client:

- greater program / time flexibility for both fabrication and installation on site
- clean and efficient fabrication
- speedy installation on site
- smooth, problem-free strand-pushing operation
- potentially smaller ducting diameter and hence greater effective depth achievable

Generally, the prefabricated tendons are coiled onto reels, shorter tendons might, however, be delivered loose or on trusses. While off-site tendon prefabrication is our preferred option, this is not always possible. A number of factors – such as length and weight of tendons, duct diameter, as well as the available space and clearance on site – may dictate that on-site cable fabrication is necessary.



3



4



5



6

### 1 Strand installation in the workshop

The fixed strand pushing arrangement allows for speedy and efficient strand installation.

### 2 Coiling onto reel

Usually, tendons are coiled onto the reels with the help of a fork-lift truck. The reels must be of an appropriate diameter, to avoid cracking or kinking of the sheathing.

### 3 Transportation to site

The reels of tendons are loaded onto a truck, along with the uncoiling frame, for delivery to the construction site.

### 4 Storage

Tendons must be stored in sheltered conditions prior to installation to protect them from water ingress.

### 5 Uncoiling

Here, the tendon reel is being secured to the uncoiling frame and being lifted by a crane.

### 6 Tendon placement

Placing of a tendon into position as it is being uncoiled. The uncoiling frame, with its braking device, must be operated by experienced staff only. The handling requires certain procedures to avoid uncontrolled overturning or uncoiling. ●

## INSIGHT

MRR technology and techniques used by BBR Network Members

# REVIVING THE BUILT ENVIRONMENT



It is well-recognized that BBR technology promotes leaner new construction, but what about maintenance, retrofit and restoration or renovation (MRR) projects? With the three 'Rs' – Reduce, Reuse, Recycle – playing an ever greater role in a cost-conscious and environmentally aware world, specialist techniques and technology used by BBR Network Members are also delivering leading edge green and economic solutions.

The need for the BBR Network's range of MRR techniques arises from a number of factors. Often, it is a case of repairing damage whether through prolonged or heavier-than-planned usage or insufficiencies in the original design of a building – although constructed to the highest standards of the day, several decades ago. However, sometimes such techniques are used to assist the repurposing of a building or structure or to ensure its continued life through a change in environmental conditions. Four key techniques feature again-and-again in our project portfolio – fiber reinforced polymer (FRP) application, bearing replacement, external post-tensioning and Impressed Current Cathodic Protection (ICCP). These are sometimes used together and sometimes with other specialist procedures, such as heavy lifting.





2



3



4

#### Fiber reinforced polymer

FRP has the advantage of being lightweight, yet strong. Additional shear capacity, flexural strength and ductility can be applied to beams, columns, slabs and walls by the application of fiber reinforced polymer materials – with minimal disturbance to occupancy and rentable asset space. It is applied as a 'wrap' or in strips to strengthen weak or damaged concrete. Following the New Zealand earthquakes in 2011, many concrete columns at The Palms Shopping Center in Christchurch needed repair. The local BBR Network Member, BBR Contech, carried out repairs to the column extremities, including forming and pouring with fine aggregate concrete and structural mortar before confining the columns with carbon fiber wrap.

In another project, this time executed by BBR Polska, FRP strips were applied for strengthening to the underside of floor slabs in an office building in Warsaw.

#### Bearing replacement

Typically, bearings are found in bridges and form a cushion between the bridge piers and the bridge deck. Replacing bridge bearings, when they have reached the end of their design life, requires the development of precise procedures and the application of heavy lifting techniques – jacking – to raise the bridge deck to allow removal and insertion of bearings.

The type of challenges met and professionally executed by BBR Network Members is well demonstrated by a project carried out on the Morshead Overpass in Melbourne, Australia. Here, there were two types of bearing – elastomeric and mechanical – and replacement procedures for each type of bearing were specifically designed. Working space limitations and further structural issues led to the creation of prefabricated steel angle brackets to support the jacks for replacement of the elastomeric bearings. The replacement method for the mechanical bearings was much simpler in terms of jacking, as there was enough space on the crosshead to seat the jack behind the existing bearing. ➤

**External PT strengthening**

The use of externally placed post-tensioning tendons to increase load carrying capacity is a well-established practice. In principle, induced tensile stresses in concrete due to additional loading can be negated by applying compressive stresses induced by post-tensioning. The technique is used mainly in bridges, where additional load carrying capacity is often required.

For example, BBR VT CONA CMB external band tendons were applied to three large bridges on Germany's A45 federal motorway by BBR Network Member KBVT. The bridges were built in the 1960s and 70s and damage made the repairs a matter of urgency. These emergency repairs have ensured the continued service of the bridges for a further ten years – by which time they will have been replaced by new ones.

External post-tensioning can be applied to buildings to increase structural strength. "External tendons strengthen and increase the load capacity of a structure and their effect comes into play immediately after they are stressed," says Bartosz Lukijaniuk of BBR Polska, "hence the technology often being called 'active' strengthening."

He and his team designed and installed the external post-tensioning system for the strengthening of three leaking concrete tanks at Warsaw's 'South' sewage plant. The BBR VT CONA CME external system was used, anchored in steel blocks fixed to the corners of the tanks.

Also in Poland, girders supporting the concrete slab of a staff car park in Siedlce were discovered to be deflecting. BBR Polska was contracted to come up with a strengthening solution and to deliver, install, stress and grout the tendons. Stressing force was calculated for each girder individually and then four strand BBR VT CONA CME external tendons were installed under each steel girder.



5



6



7



“External tendons strengthen and increase the load capacity of a structure and their effect comes into play immediately after they are stressed,”



8

### Impressed Current Cathodic Protection

Impressed Current Cathodic Protection (ICCP) systems are installed to inhibit the corrosion of steel reinforcing bars in concrete structures – particularly if the latter are in aggressive marine environments. The systems operate by passing a low voltage current through strategically placed anodes inserted into the concrete which forces the reinforcing steel into a cathodic state and protects it from corrosion. The ICCP control system monitors and records performance. An ICCP system was installed by BBR Contech on the Kaikorai estuary bridge in Dunedin, New Zealand. The system can be monitored and adjusted as necessary. Strict operational specifications were applied during the repair and installation work to protect the estuary’s wetlands ecosystem. Meanwhile, in Singapore, BBR Construction Systems installed an ICCP system to

control corrosion on a section of the Central Expressway under the Singapore River. There had been significant problems with water seepage and chunks of concrete had fallen from the tunnel ceiling. Early data collected has indicated that the system will offer considerable savings in long-term repair costs.

The expertise of the BBR Network in the area of maintenance, repair and retrofit or renovation is founded on a long experience and understanding of structures, as well as the professional, effective and safe application of the latest technologies. As building and asset owners and managers seek to manage their risks – whether they are building new structures or repairing, protecting or strengthening existing ones – the BBR Network is ready with robust, well thought-out solutions to help them ensure structural resilience for the long term. ●

- 1 The roof structure of the Olivia Sports Hall, Gdansk – consisting of ten 80m long 3D steel trusses – was strengthened externally with 18 BBR VT CONA CME tendons by BBR Polska.
- 2 At The Palms Shopping Center, Christchurch, New Zealand, many concrete columns were repaired by BBR Contech using fiber reinforced polymer wrap after the 2011 earthquakes.
- 3 The elastomeric and mechanical bearings on Morshead Overpass, Melbourne, Australia were replaced using innovative techniques devised by local BBR Network Member, Structural Systems.
- 4 Fiber reinforced polymer strips were applied to the underside of floor slabs within the an office building Warsaw by BBR Polska.
- 5 BBR VT CONA CMB external band tendons were applied to strengthen three large bridges on Germany’s A45 federal motorway by BBR Network Member KB Vorspann-Technik.
- 6 BBR Polska designed and installed the external post-tensioning system – using the BBR VT CONA CME external system – for the strengthening of three leaking concrete tanks at Warsaw’s ‘South’ sewage plant.
- 7 Deflecting girders supporting the concrete slab of a staff car park in Siedlce were strengthened by BBR Polska using four strand BBR VT CONA CME external tendons installed under each steel girder.
- 8 An ICCP system is monitored and adjusted by BBR Contech on the Kaikorai estuary bridge installation in Dunedin, New Zealand.

## THINKING ALOUD

Paul Wymer, Managing Director of BBR Contech, the New Zealand-based BBR Network Member shares some thoughts about how to adapt successfully to changed circumstances

# EMBRACING NEW BEGINNINGS



Over the past few years in New Zealand, we've all had to act and adapt to changed circumstances that were caused by factors outside of our control. After the Canterbury earthquakes, we deployed our people – according to their skills, experience and expertise – to help in the recovery. Life here will never be quite the same again – the 'old normal' has gone forever and we are working together to establish a 'new normal'. In a sense, this is a new beginning for us and it has made me think about the wider issue of the global economy and how a similar approach may be needed.

After one of the longest and deepest recessions in living memory, we must acknowledge that the world economy is, at best, volatile and uncertain – and that it may never return to what we previously considered to be 'normal'. Yet, as we look around us, there are indeed businesses which are prospering – even new businesses starting – despite the vagaries of the economic climate. This is happening because we're creating a new order of things – realigning ourselves and our aspirations to compete in this challenging environment. We have begun a new phase in our journey. It is one that must bring new people together, foster different ways of thinking and introduce new technologies into the market to enable us to contend with our new circumstances. While our market strategies might need a little polishing, the core values which underpin everything we do must remain the same – dedication and commitment to innovation, collaboration, quality and service excellence. As we navigate down this new path, we must all expand our thinking, face some

brutal facts about what may lay ahead and be prepared to change our habits. This takes courage and conviction in this 'new normal' environment where the outcomes can be uncertain. We need to listen carefully to new people and new ways of doing things – and then apply all of our experience and wisdom to discovering how we can integrate these insights to move forward successfully. If we suppress these new ideas, we risk standing still – and even worse, we will fail to encourage and exploit the maximum from our new emerging talent. The 2012 New Zealander of the Year, Sir Ray Avery said "Live like you are going to die tomorrow and learn like you are going to live forever." We can gain some inspiration from this as we diligently pursue new ideas – not always without risk – and at the same time nurture a strong learning culture. These things certainly help to expand our horizons, reset our personal navigation devices along the way and make us ready and able to embrace new beginnings. ●

## HEADQUARTERS

BBR VT International Ltd  
 Bahnstrasse 23  
 8603 Schwerzenbach-Zurich  
 Switzerland  
 Tel +41 44 806 80 60  
 Fax +41 44 806 80 50  
 www.bbrnetwork.com  
 info@bbrnetwork.com

## EUROPE

 **AUSTRIA**  
 KB Vorspann-Technik GmbH  
 Schillerstrasse 25  
 5020 Salzburg  
 Tel +43 662 456516  
 Fax +43 662 456516-11  
 www.kb-vt.com  
 office@kb-vt.com

 **BELGIUM**  
 see Netherlands

 **BOSNIA & HERZEGOVINA**  
 see Croatia

 **BULGARIA**  
 see Spain

 **CROATIA**  
 BBR Adria d.o.o.  
 Kalinovica 3, 10000 Zagreb  
 Tel +385 1 3839 220  
 Fax +385 1 3839 243  
 www.bbr-adria.com  
 bbr-adria@bbr-adria.com

 **DENMARK**  
 see Norway

 **ESTONIA**  
 see Austria

 **FINLAND**  
 see Norway

 **FRANCE**  
 ETIC S.A.S.  
 3 rue de Marly  
 78 000 Versailles  
 Tel +33 1 39 50 11 20  
 Fax +33 1 39 50 11 03  
 www.etic-sas.fr  
 contact@etic-sas.fr

 **GERMANY**  
 KB Vorspann-Technik GmbH  
 Furstenrieder Strasse 275  
 81377 Munchen  
 Tel +49 89 72 44 969-0  
 Fax +49 89 72 44 969-12  
 www.kb-vt.com  
 office@kb-vt.com

 **IRELAND**  
 see United Kingdom

 **KOSOVO**  
 see Croatia

 **LATVIA**  
 see Austria

 **LITHUANIA**  
 see Austria

 **MONTENEGRO**  
 see Croatia

 **NETHERLANDS**  
 Spanstaal – Ballast Nedam Infra  
 Specialiteiten B.V.  
 Nijverheidstraat 12, 4143 HM Leerdam  
 Post Address: PO Box 236, 4140 AE Leerdam  
 Tel +31 345 63 92 00  
 Fax +31 345 61 91 07  
 www.spanstaal.nl  
 info@spanstaal.nl

 **NORWAY**  
 KB Spennteknikk AS  
 Siva Industrial Estate, N. Strandsveg 19-21  
 Postboks 1213, 2206 Kongsvinger  
 Tel +47 62 81 00 30  
 Fax +47 62 81 00 55  
 www.spennteknikk.no  
 spennteknikk@spennteknikk.no

 **POLAND**  
 BBR Polska Sp. z o.o. (Head Office)  
 ul. Annopol 14, 03-236 Warszawa  
 Tel +48 22 811 50 53  
 Fax +48 22 676 92 31  
 www.bbr.pl  
 bbrpolska@bbr.pl

BBR Polska Sp. z o.o.  
 ul. Tarnogorska 214a, 44-105 Gliwice  
 Tel +48 32 331 47 98  
 Fax +48 32 330 24 11  
 www.bbr.pl  
 bbrpolska.gliwice@bbr.pl

 **PORTUGAL**  
 see Spain

 **ROMANIA**  
 see Spain

 **RUSSIA**  
 see Germany

 **SERBIA**  
 see Croatia

 **SLOVENIA**  
 see Croatia

 **SPAIN**  
 BBR Pretensados y Técnicas Especiales, S.L.  
 Antigua Carretera N-III, Km. 31, 150  
 28500 Arganda del Rey, Madrid  
 Tel +34 91 876 09 00  
 Fax +34 91 876 09 01  
 www.bbrpte.com  
 bbrpte@bbrpte.com

 **SWEDEN**  
 Spännteknik AB  
 Sjöängsvägen 7,  
 192 72 Sollentuna  
 Tel +46 8 510 678 10  
 Fax +46 8 510 678 19  
 www.spannteknik.se  
 info@spannteknik.se

 **SWITZERLAND**  
 Stahlton AG  
 Hauptstrasse 131  
 5070 Frick  
 Tel +41 44 938 99 00  
 Fax +41 44 422 11 16  
 www.stahlton.ch  
 info@stahlton.ch

 **UKRAINE**  
 see Poland

 **UNITED KINGDOM**  
 Structural Systems (UK) Ltd  
 12 Collett Way  
 Great Western Industrial Estate  
 Southall, Middlesex, UB2 4SE  
 Tel +44 20 8843 6500  
 Fax +44 20 8843 6509  
 www.structuralsystemsuk.com  
 info@structuralsystemsuk.com



**AFRICA**

 **SOUTH AFRICA**  
 Structural Systems (Africa)  
 Group Five House  
 9 Country Estate Drive  
 Waterfall Business Estate  
 Jukskei View  
 Johannesburg 2090  
 Tel +27 10 060 1555  
 Fax +27 86 616 7482  
[www.structuralsystemsafrika.com](http://www.structuralsystemsafrika.com)  
[info@sslafrica.com](mailto:info@sslafrica.com)



**AMERICAS**

 **EASTERN CANADA**  
 Canadian bbr Inc.  
 3450 Midland Ave.  
 Scarborough  
 Ontario M1V 4V4  
 Tel +1 416 291 1618  
 Fax +1 416 291 9960  
[mducommun@bbrcanada.com](mailto:mducommun@bbrcanada.com)



**MIDDLE EAST**

 **BAHRAIN**  
 see United Arab Emirates

 **SYRIA**  
 see Jordan

 **JORDAN**  
 Marwan Alkurdi & Partners Co. Ltd  
 PO Box 506, Amman 11821  
 Tel +962 6 581 9489  
 Fax +962 6 581 9488  
[www.mkurdi.com](http://www.mkurdi.com)  
[ali@mkurdi.com](mailto:ali@mkurdi.com)

 **UNITED ARAB EMIRATES**  
 NASA Structural Systems LLC  
 (Head Office)  
 Office M 03, Bu Shaqar Building  
 Garhoud  
 PO Box 28987  
 Dubai  
 Tel +971 4 2522 501  
 Fax +971 4 2522 502  
[www.bbrstructuralsystems.com](http://www.bbrstructuralsystems.com)  
[bbr@bbrstructuralsystems.com](mailto:bbr@bbrstructuralsystems.com)

 **KUWAIT**  
 see Jordan

 **OMAN**  
 Structural Systems Limited (Oman Branch)  
 Office A-11, Al Souruh Building  
 Al Ghala Industrial  
 PO Box 1946, PC-130  
 Muscat, Sultanate of Oman  
 Tel +968 2459 5279  
 Fax +968 2459 5252  
[www.bbrstructuralsystems.com](http://www.bbrstructuralsystems.com)  
[bbr@bbrstructuralsystems.com](mailto:bbr@bbrstructuralsystems.com)

Structural Systems Middle East LLC  
 Office 38, Sheikh Abdullah Bin Zayed Al Nahyan  
 Industrial Area  
 Musaffah-2  
 P O Box 126740  
 Abu Dhabi  
 Tel +971 2 5554 347  
 Fax +971 2 5554 348  
[www.bbrstructuralsystems.com](http://www.bbrstructuralsystems.com)  
[bbr@bbrstructuralsystems.com](mailto:bbr@bbrstructuralsystems.com)

 **QATAR**  
 see United Arab Emirates

Emirates & Australia Const.  
 Systems LLC  
 Office 112  
 Hatem Kamal Farah Building  
 Beirut Street  
 PO Box 62174  
 Sharjah  
 Tel +971 6 5437 490  
 Fax +971 6 5437 491  
[www.bbrstructuralsystems.com](http://www.bbrstructuralsystems.com)  
[bbr@bbrstructuralsystems.com](mailto:bbr@bbrstructuralsystems.com)

 **KINGDOM OF SAUDI ARABIA**  
 Huta-Hegerfeld Saudia Ltd  
 BBR Prestressing Division  
 Prince Sultan St. Lotus Building  
 PO Box 1830, Jeddah 21441  
 Tel +966 12 662 3205  
 Fax +966 12 683 1838  
[www.hutahegerfeld.com.sa](http://www.hutahegerfeld.com.sa)  
[bbr@huta.com.sa](mailto:bbr@huta.com.sa)

## ASIA PACIFIC

 MALAYSIA

BBR Construction Systems (M) Sdn Bhd  
No. 17, Jalan PJS 11/2  
Bandar Sunway  
46150 Subang Jaya  
Selangor Darul Ehsan  
Tel +60 3 5636 3270  
Fax +60 3 5636 3285  
www.bbr.com.my  
enquiry@bbr.com.my

 PHILIPPINES

BBR Philippines Corporation  
Suite 502, 7 East Capitol Building  
No.7 East Capitol Drive  
Barangay Kapitolyo  
Pasig City, Metro Manila 1603  
Tel +632 638 7261  
Fax +632 638 7260  
jcf.admin@bbr.com.ph

 SINGAPORE

BBR Construction Systems Pte Ltd  
BBR Building  
50 Changi South Street I  
Singapore 486126  
Republic of Singapore  
Tel +65 6546 2280  
Fax +65 6546 2268  
www.bbr.com.sg  
enquiry@bbr.com.sg

 THAILAND

see Singapore

 VIETNAM

see Singapore

 AUSTRALIA

Structural Systems (Northern) Pty Ltd  
20 Hilly Street, Mortlake  
New South Wales 2137  
Tel +61 2 8767 6200  
Fax +61 2 8767 6299  
www.structuralsystems.com.au  
info@nsw.structural.com.au



Structural Systems (Northern) Pty Ltd  
Unit 1/12 Commerce Circuit  
Yatala, Queensland 4207  
Tel +61 7 3442 3500  
Fax +61 7 3442 3555  
www.structuralsystems.com.au  
info@qld.structural.com.au

Structural Systems (Southern) Pty Ltd  
PO Box 1303  
112 Munro Street, South Melbourne  
Victoria 3205  
Tel +61 3 9296 8100  
Fax +61 3 9646 7133  
www.structuralsystems.com.au  
info@structural.com.au

Structural Systems (Southern) Pty Ltd  
39 Howards Road  
Beverly SA 5009  
Tel +61 8 8268 0400  
Fax +61 8 8268 0401  
www.structuralsystems.com.au  
info@structural.com.au

Structural Systems (Western) Pty Ltd  
3 Craig St, Burswood  
Western Australia 6100  
Tel +61 8 9267 5400  
Fax +61 8 9267 5499  
www.structuralsystems.com.au  
info@wa.structural.com.au

 FIJI

see New Zealand

 NEW ZEALAND

BBR Contech  
6 Neil Park Drive, East Tamaki  
PO Box 51-391  
Pakuranga, Auckland 2140  
Tel +64 9 274 9259  
Fax +64 9 274 5258  
www.contech.co.nz  
akl@contech.co.nz

BBR Contech  
38 Waione Street, Petone  
PO Box 30-854  
Lower Hutt, Wellington 5040  
Tel +64 4 569 1167  
Fax +64 4 569 4269  
www.contech.co.nz  
wgn@contech.co.nz

BBR Contech  
7A Birmingham Drive, Middleton  
PO Box 8939  
Riccarton, Christchurch 8440  
Tel +64 3 339 0426  
Fax +64 3 339 0526  
www.contech.co.nz  
chc@contech.co.nz

